

American Girl[®]



Luciana's Space Camp[®] Adventures • Les aventures de Luciana au Space Camp[®]
Aventuras de Space Camp[®] de Luciana

FTY39

Space Camp[®] is a registered trademark and service mark of the U.S. Space & Rocket Center[®]. All rights reserved. ©2018 Alabama Space Science Exhibit Commission.

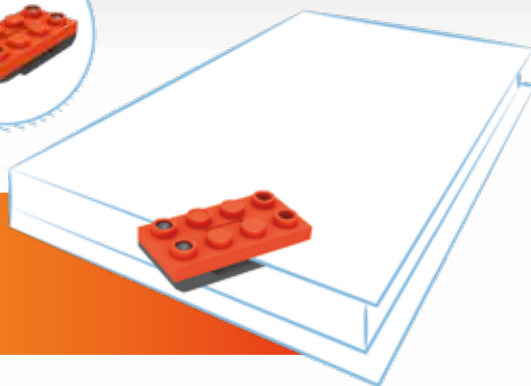
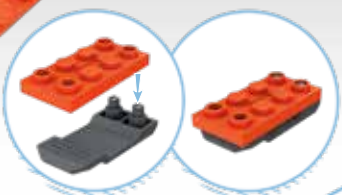

Clip it! • Accrochez ! • ¡Abróchalo!
 Prende! • Aggancialo! • Klipp-Baustein!
 Przyczep! • Clip 'm vast! • Прикрепляй!
 Κομπώστε! • Tak! • اشيكلها!

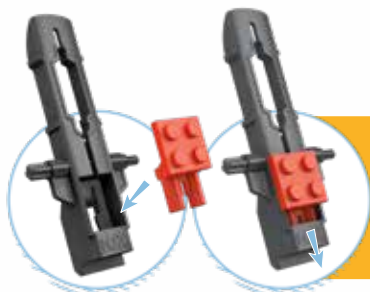

Separate it! • Séparez-le ! • ¡Sepáralo!
 Separa! • Die Teile trennen! • Rozłącz!
 Maak 'm los! • Отсоедини! • Διαχωρίστε! • Ayır!
 افضلها!



Learn more • Pour en savoir plus • Más información • Sabe mais • Impara altro • Weitere Infos gibt es auf
 Dowiedz się więcej • Meer informatie • Узнать больше • Μάθετε περισσότερα • Daha fazla bilgi için • اكتشف المزيد!

play.megaconstrux.com

LET'S GET STARTED • POUR COMMENCER
EMPECEMOS • VAMOS COMEÇAR



MEET LUCIANA
VOICI LUCIANA
CONOCE A LUCIANA
CONHEÇA A LUCIANA

p.4

START BUILDING
COMMENCE À CONSTRUIRE
EMPIEZA A CONSTRUIR
COMEÇAR A MONTAR

p.7



LUCIANA'S ACTIVITIES
LES ACTIVITÉS DE LUCIANA
ACTIVIDADES DE LUCIANA
ATIVIDADES DA LUCIANA

p.77





Meet Luciana™!

Girl of the Year™ Luciana Vega knows she has what it takes to be an astronaut—creativity, confidence and a serious science streak. At Space Camp®, she's excited to get actual hands-on experience.

“Everything is so realistic,” Luci says to Ella. “I can't wait to use the mission simulator and robotics lab. And from mission control I can communicate with everyone and troubleshoot problems. It's like being a real astronaut!”

Voici Luciana™!

Voici Luciana™! La Fillette de l'année, Luciana Vega sait ce que cela prend pour être un astronaute ; créativité, confiance en soi et un sérieux penchant pour la science. Elle est très excitée de vivre l'expérience Au Camp Spatial®.

“Tout est tellement réaliste,” dit Luci à Ella. “J'ai tellement hâte d'utiliser le simulateur de mission et le laboratoire de robotique. En plus, à partir centre de contrôle, je peux communiquer avec tout le monde et régler tous les problèmes. C'est comme être une vraie astronaute!”



Conoce a Luciana™!

La chica del año, Luciana Vega, sabe que tiene lo que se necesita para ser una astronauta—creatividad, confianza y ser excelente en ciencia. En el Space Camp , Luci se siente emocionada por adquirir experiencia de primera mano.

“Todo es tan realista”, le dice Luci a Ella. “No puedo esperar para usar el simulador de misión y el laboratorio de robótica. Y desde el centro de control puedo comunicarme con todos y solucionar problemas. ¡Es como ser una verdadera astronauta! “

Conheça a Luciana™!

A Garota do Ano Luciana Vega sabe que ela tem o que precisa para ser uma astronauta: criatividade, confiança e um grande talento para a ciência. No Space Camp®, ela está animada para ter uma experiência prática real.

“Tudo é tão realista”, Luci diz a Ella. “Não posso esperar para usar o simulador de missões e o laboratório de robótica. Do controle de missão eu posso comunicar com todo mundo e resolver problemas. É como ser um astronauta de verdade!”



BUILDABLE FIGURE FIGURINE À ASSEMBLER FIGURA PARA CONSTRUIR FIGURA DE MONTAR

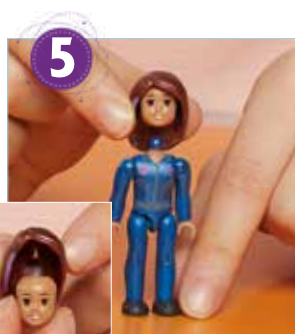

Luciana Vega™ GIRL OF THE YEAR 2018

DID YOU KNOW THAT YOU CAN PERSONALIZE YOUR AMERICAN GIRL MINI FIGURES?

Collect them all, then mix and match pieces from each to customize them. Use the different parts and accessories to change their look and style.

SAVAIS-TU QUE TU PEUX PERSONNALISER TES MINI-FIGURINES AMERICAN GIRL?

Collectionne-les toutes, puis combine des pièces de chacune pour assembler des figurines uniques. Avec les pièces et accessoires, change leur look et leur style.

¿SABÍAS QUE PUEDES PERSONALIZAR TUS MINIFIGURAS DE AMERICAN GIRL?

Colecciónalas todas, mézclalas y combina las piezas para personalizarlas. Utiliza las diferentes piezas y los diversos accesorios para cambiar su look y estilo.

VOCÊ SABIA QUE VOCÊ PODE PERSONALIZAR AS MINI FIGURAS AMERICAN GIRL?

Colecione, misture e combine as peças e deixe tudo customizado! Use as diferentes peças e acessórios para mudar o estilo.



Each sold separately and subject to availability. Produits vendus séparément, selon la disponibilité. Se venden por separado y están sujetos a disponibilidad. Vendidos em separado e sujeitos à disponibilidade.



START BUILDING • COMMENCE À CONSTRUIRE
EMPIEZA A CONSTRUIR • COMEÇAR A MONTAR



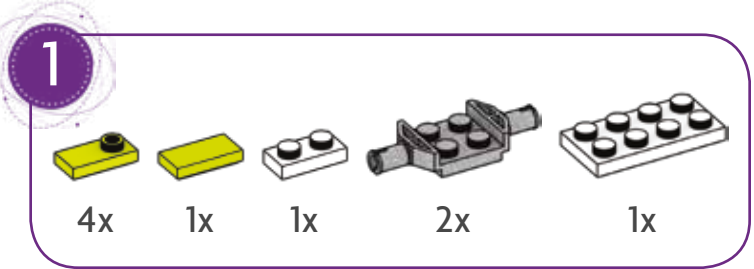
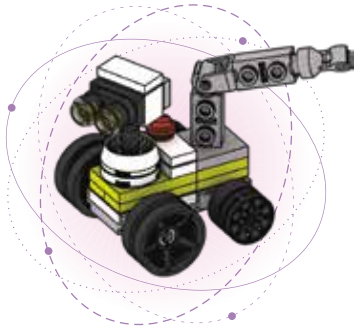

Make a rover like the one Luci builds. She uses the arm to pick up red balls that simulate red rocks from Mars.

Construit un robot comme celui de Luci. Elle utilise le bras pour ramasser des boules rouges qui simulent les roches qu'on retrouve sur Mars.

Crea un astromóvil como el que Luci construye. Ella usa el brazo robótico para recoger bolas rojas que simulan rocas rojas de Marte.

Construa um veículo como o de Luci. Ela usa o braço para pegar bolas vermelhas que simulam as rochas vermelhas de Marte.

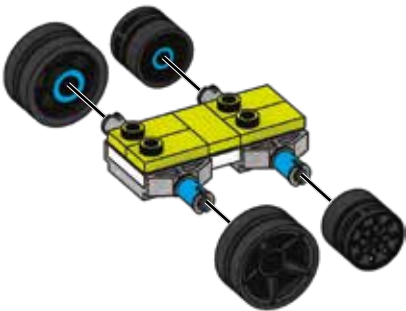
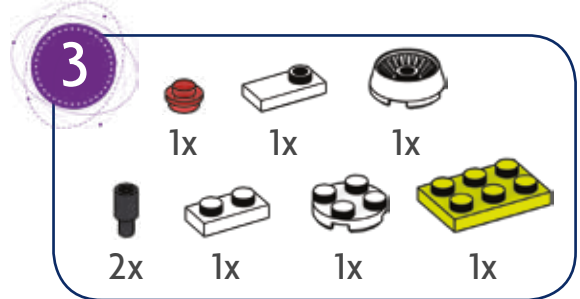
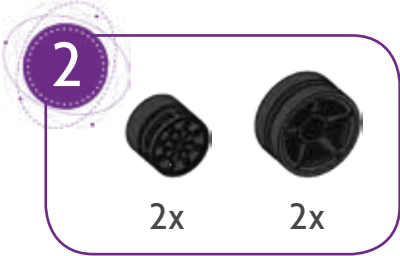
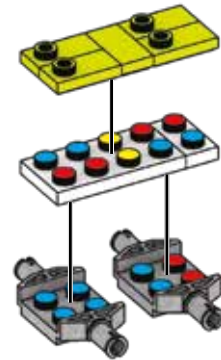

1



2

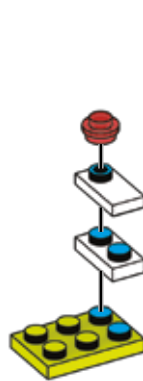

1



2



3



4

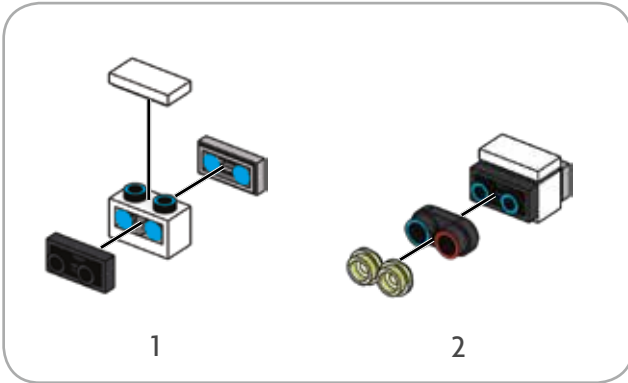
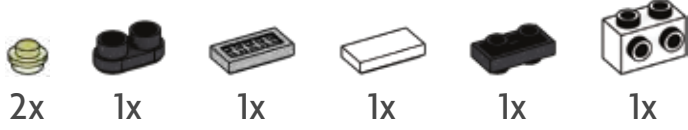

1



2

5

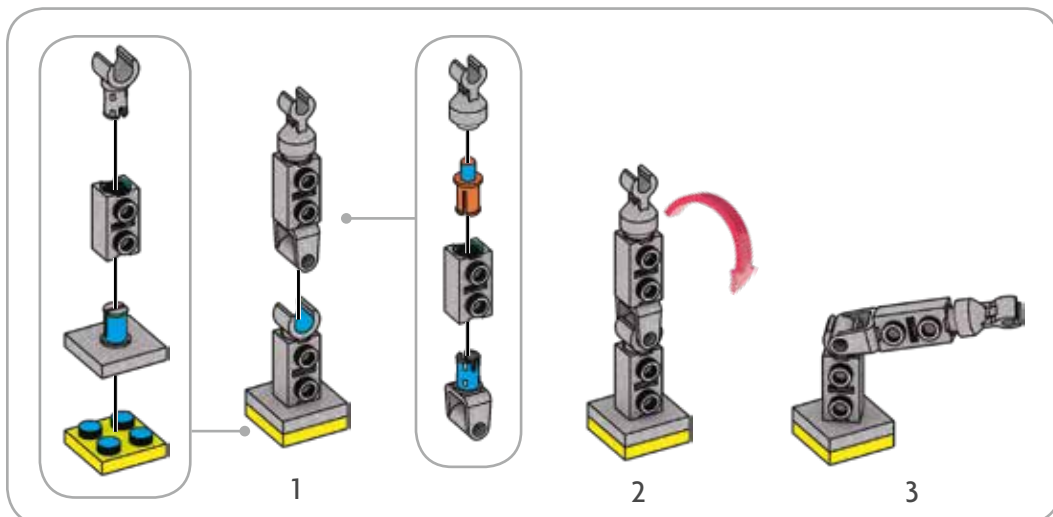
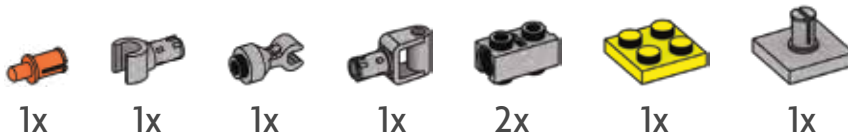



6

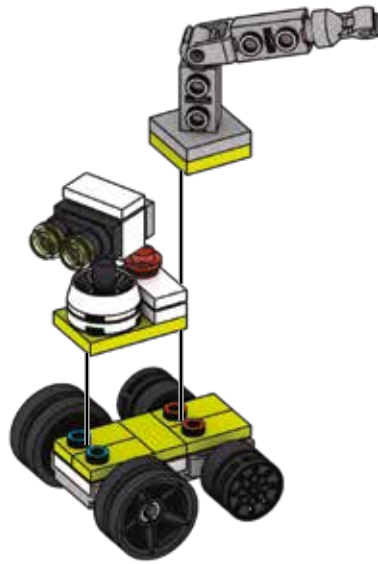

1

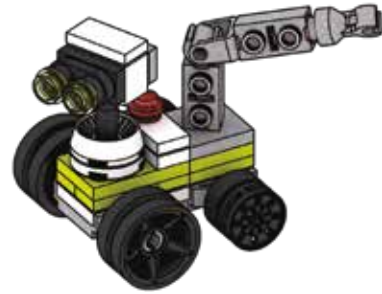

2

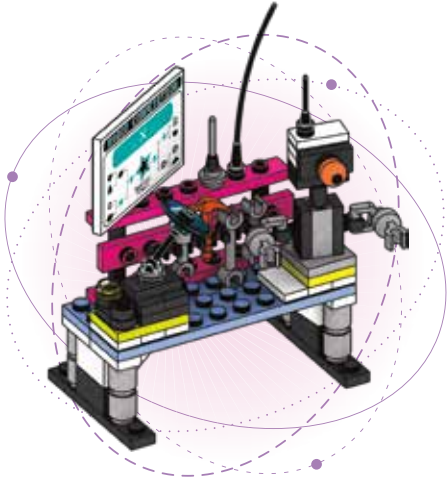

7



8x



4x



2x



2x



2x

Build the robotics lab. With all these tools, Luci knows her team can build a winning rover and robot.

Construit le laboratoire de robotique. Avec tous ces outils, Luci sait que son équipe peut construire un astromobile et un robot génial.

Construye el laboratorio de robótica. Con todas estas herramientas, Luci sabe que su equipo puede construir un robot y un astromóvil ganador

Construa o laboratório de robótica. Com todas estas ferramentas, Luci sabe que seu time pode construir veículos e robôs vencedores.

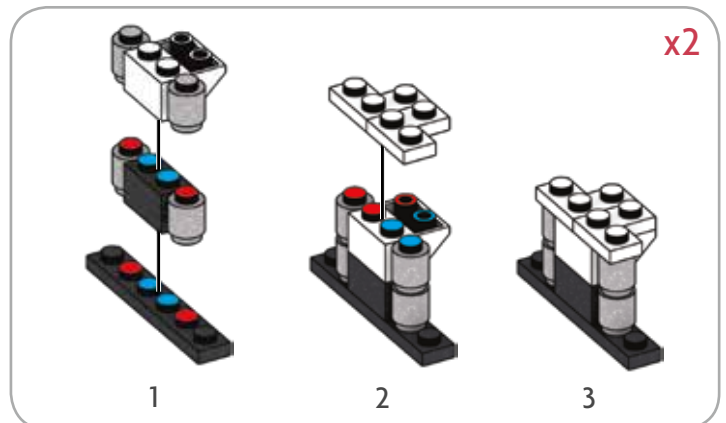

1

2

3

x2



8



2x



4x

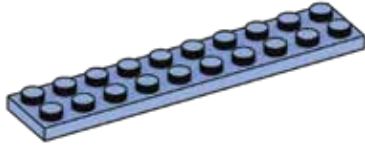

2x

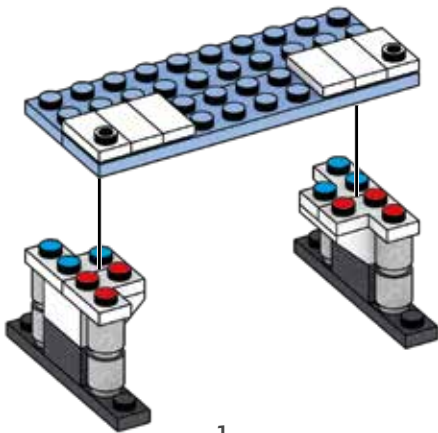
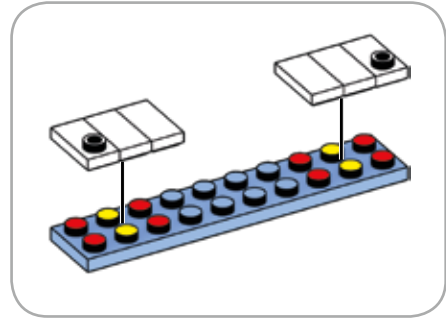

1

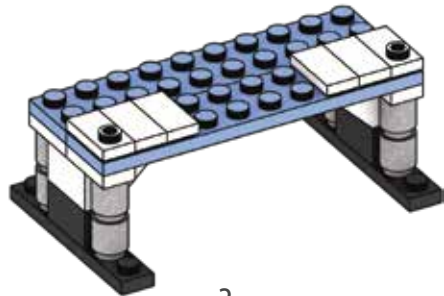

2

9



5x



2x



2x

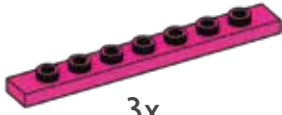

3x

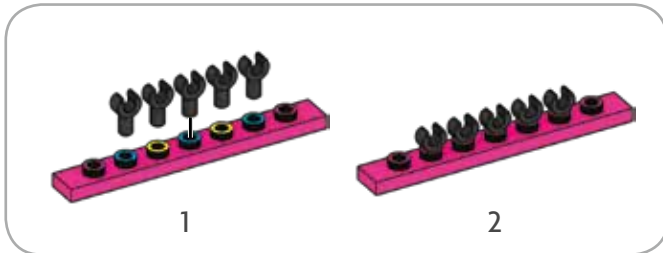

1

2

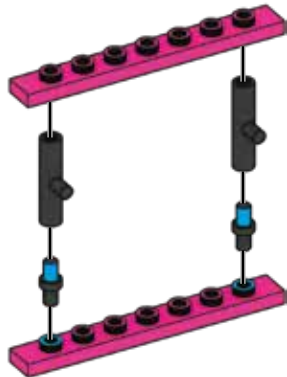

1

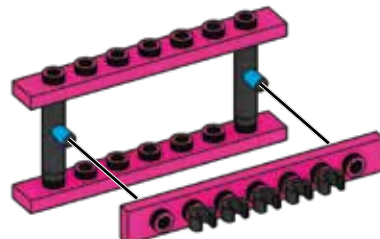

2



10



1x



1x



1x



1x



1x



1x

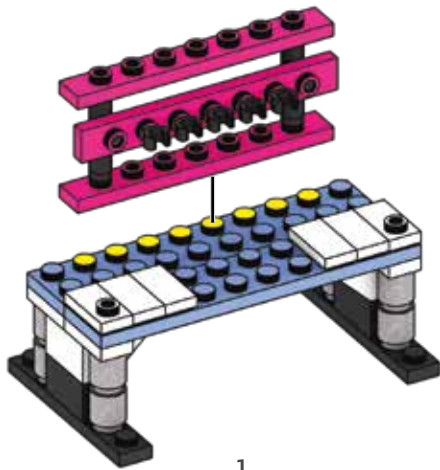

1

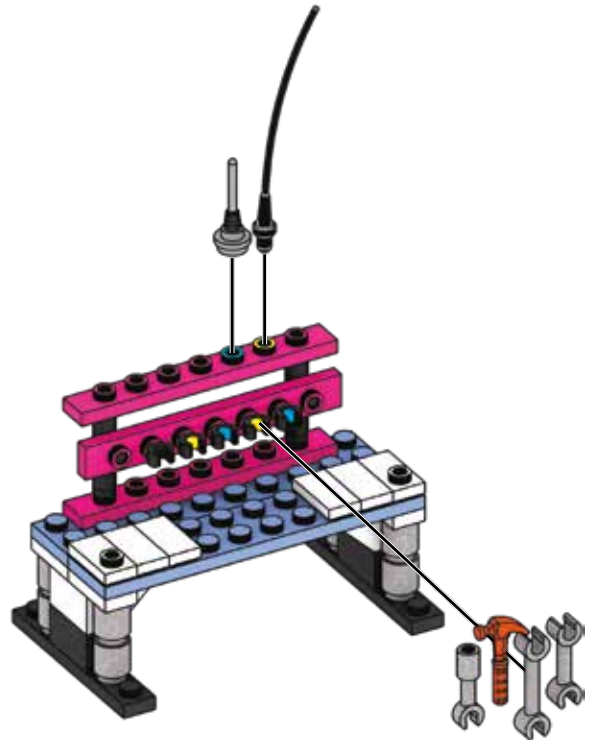

2

BUILDING TIP • CONSEIL UTILE CONSEJO PARA CONSTRUIR DICA DE MONTAGEM

Press gently when you attach the tool rack to the workbench.
Luci is excited about all the tools she gets to use!

Appuit doucement lorsque tu attaches l'étagère à outils à l'établi.
Luci est excité à propos de tous les outils qu'elle peut utiliser.

Presiona delicadamente cuando coloques el estante de
herramientas sobre la mesa de trabajo. ¡Luci está entusiasmada
con todas las herramientas que puede usar!

Pressione suavemente quando for colocar o porta-ferramentas
na bancada de trabalho. Luci está animada com todas as
ferramentas ela poderá usar!

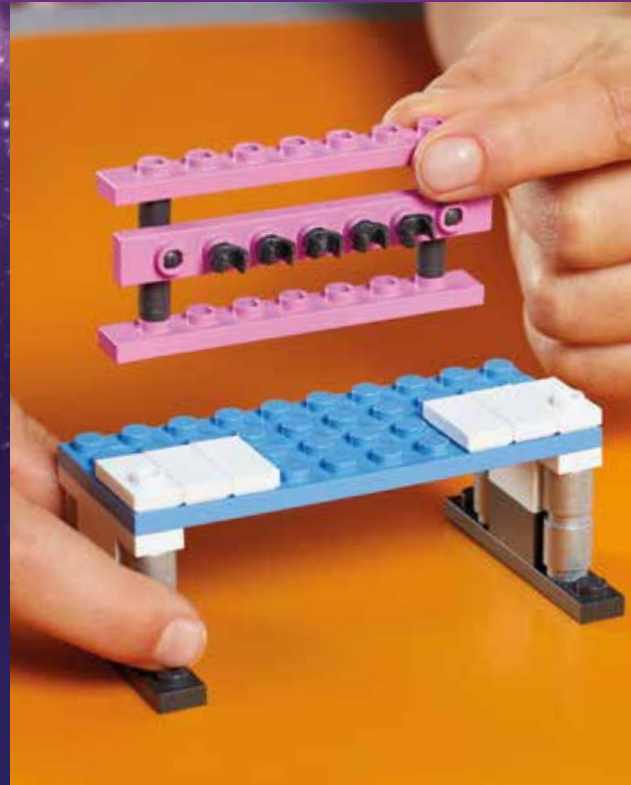





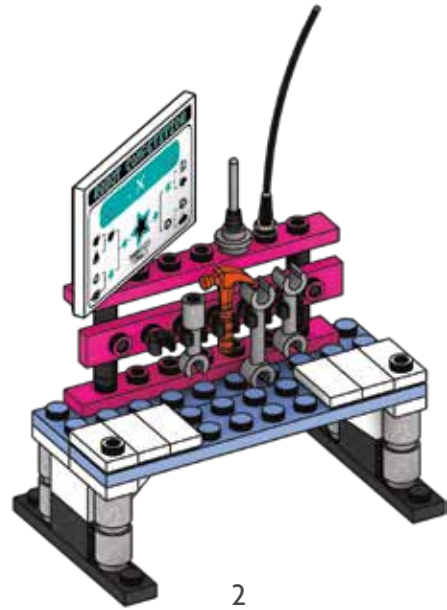
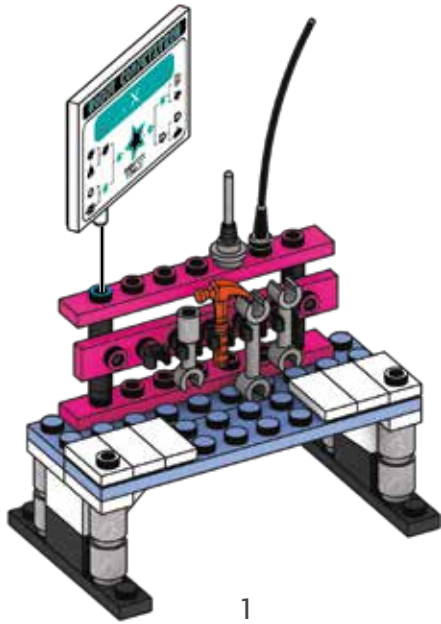
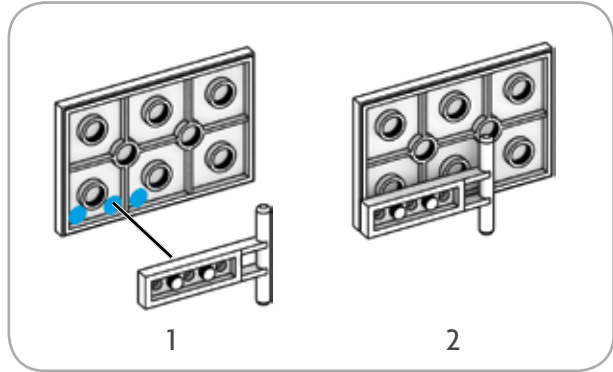
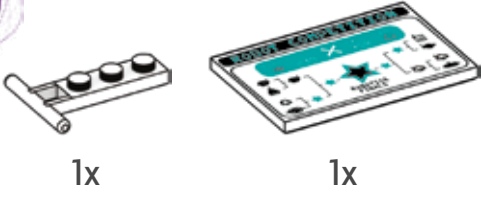





11





12

-  1x
-  1x
-  1x
-  1x
-  1x
-  1x
-  1x
-  3x
-  1x
-  1x



1



2



3



4





5

13

-  2x
-  1x
-  1x
-  1x

14

-  2x
-  2x
-  2x

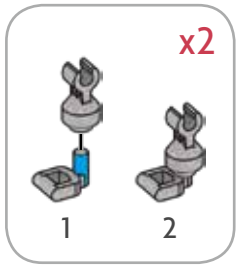
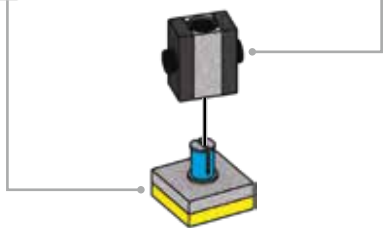
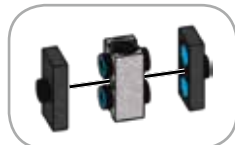
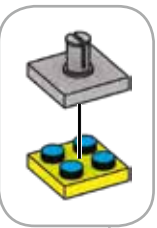



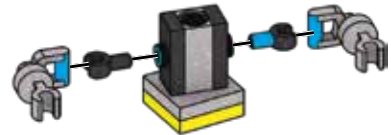







x2





15

- 1x 
- 1x 
- 1x 
- 1x 
- 1x 
- 1x 
- 2x 
- 1x 
- 1x 
- 1x 

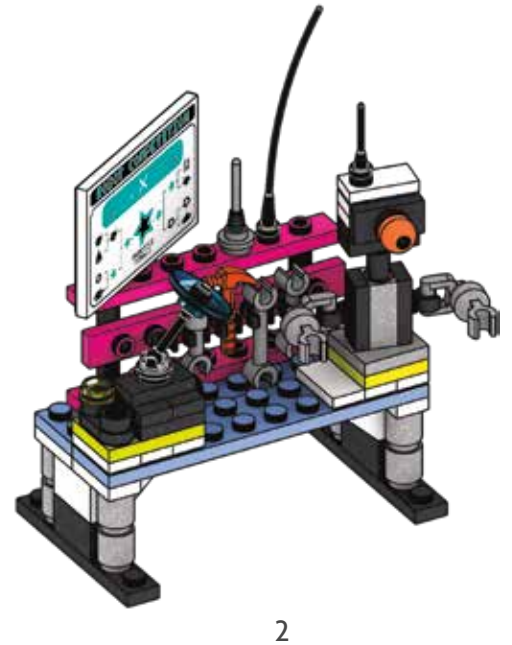
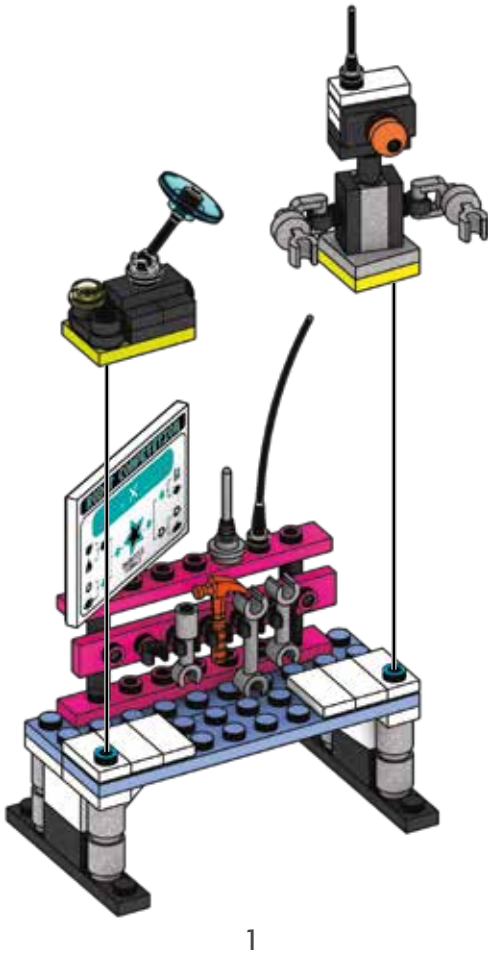
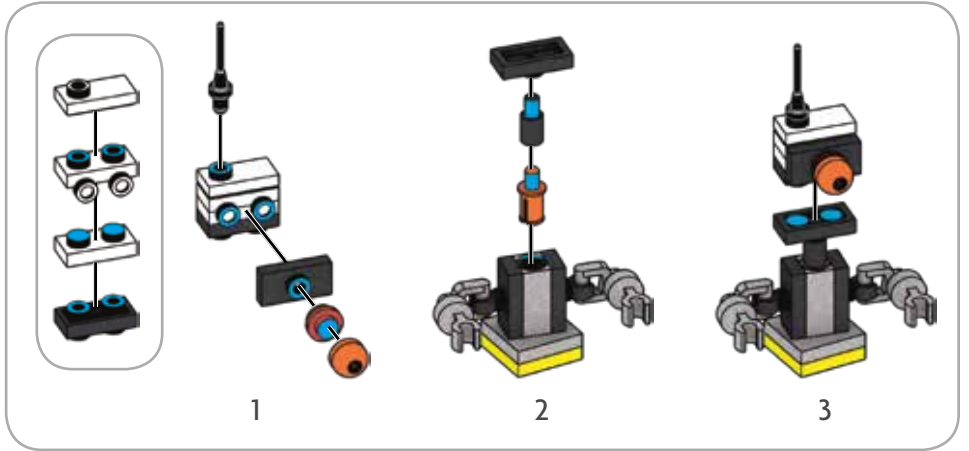

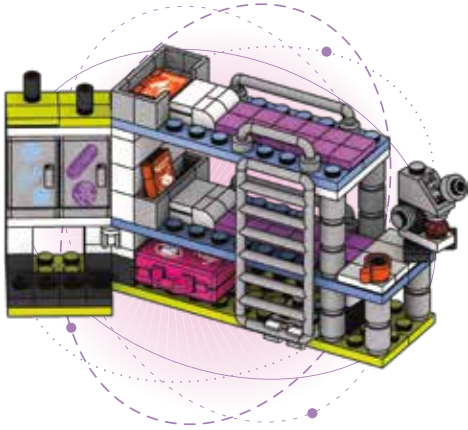

16

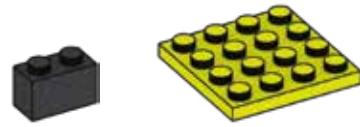

2x

1x

Build a bunk bed and locker for Luci and Ella's room.
Ella calls top bunk!

Construit un lit superposé et un casier pour la
chambre de Luci et Ella. Ella prend celui du haut!

Construye una litera y un armario para la habitación de
Luci y Ella. ¡Ella quiere la litera superior!

Construa um beliche e armário para o quarto de
Luci e Ella. Ella quer a cama de cima!

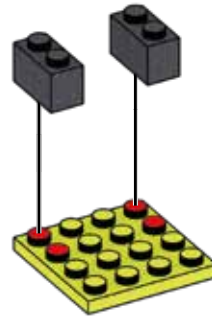

17



4x

18

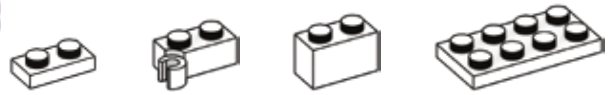

1x

1x

1x

1x

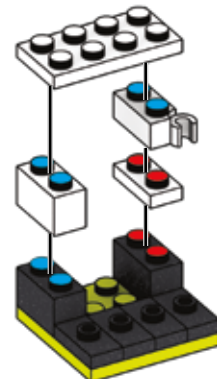
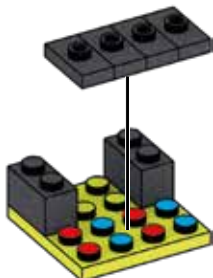



19

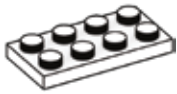

1x



1x



1x



2x

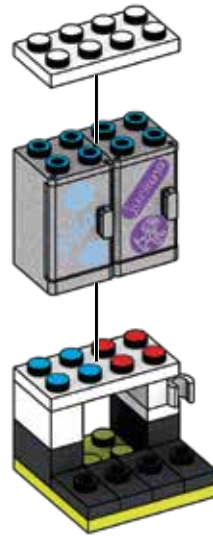
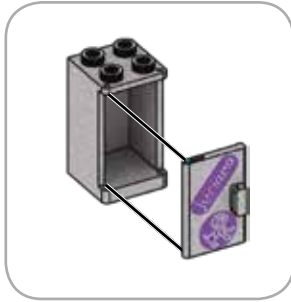
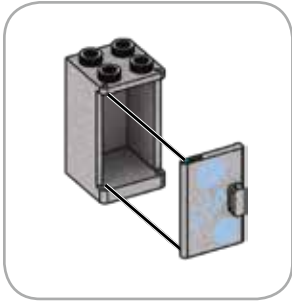

20



2x



2x



2x



1



2



21



4x



1x

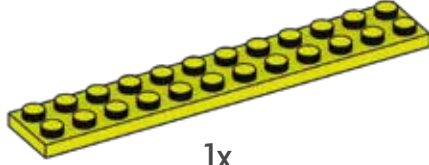

1x

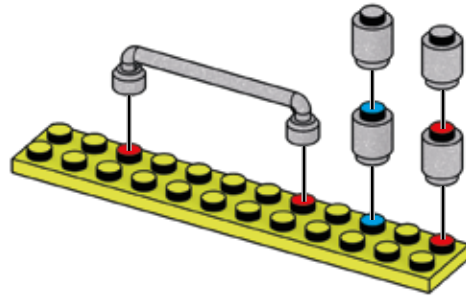

22



1x



1x

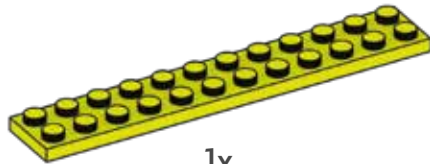

1x

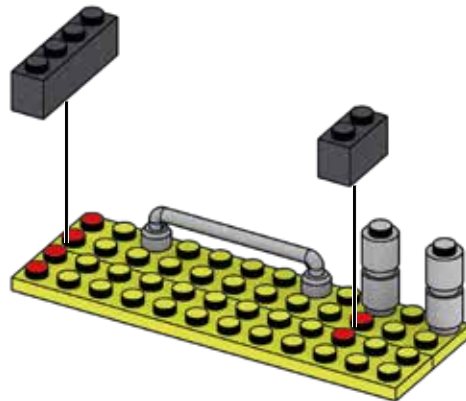



23



2x



1x



1x



1x



1x

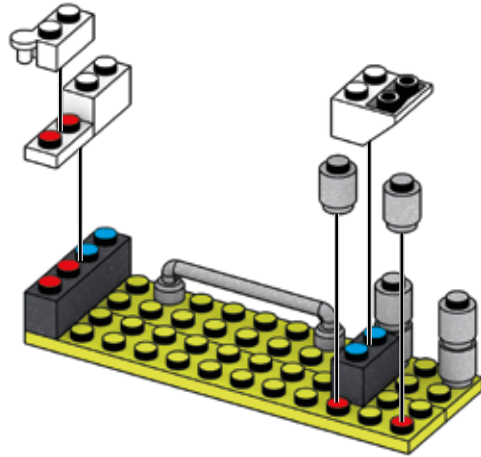

24



2x



1x

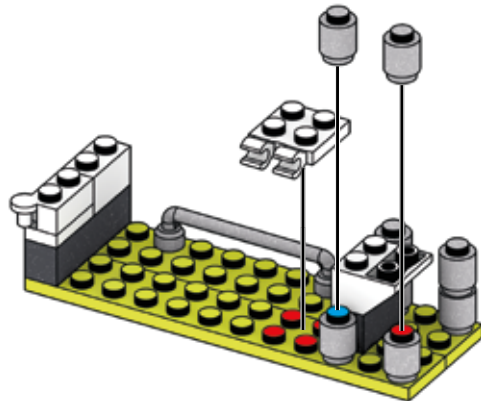



25

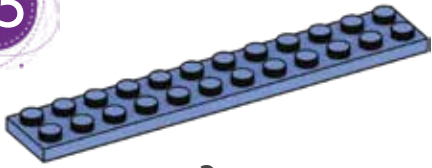

2x

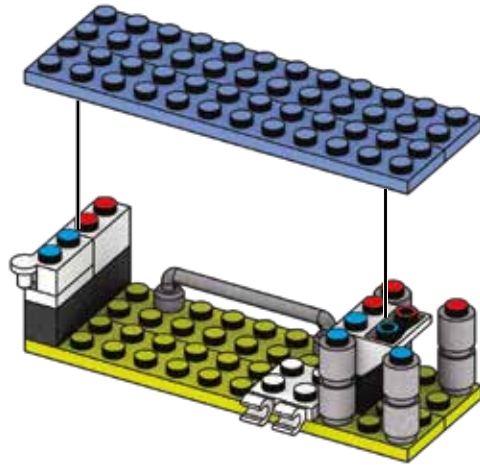

26



2x



1x

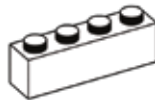

1x



1x

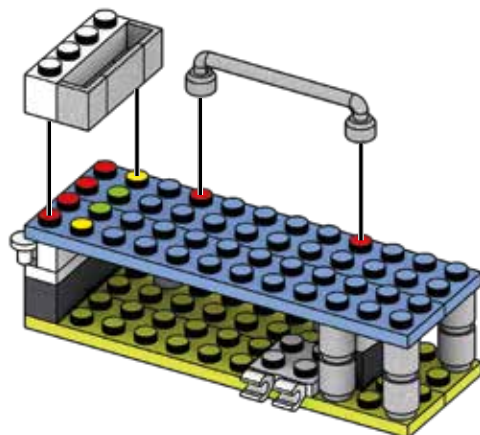



27



2x



1x



1x

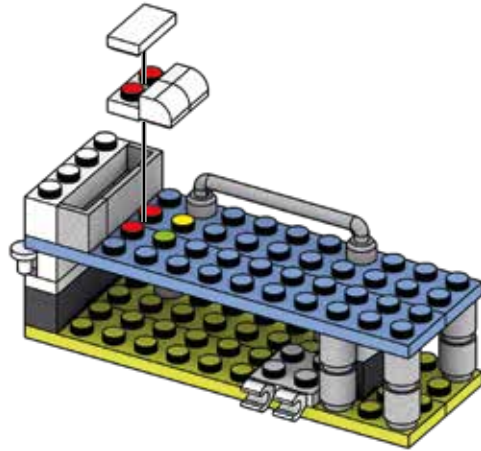

28



6x

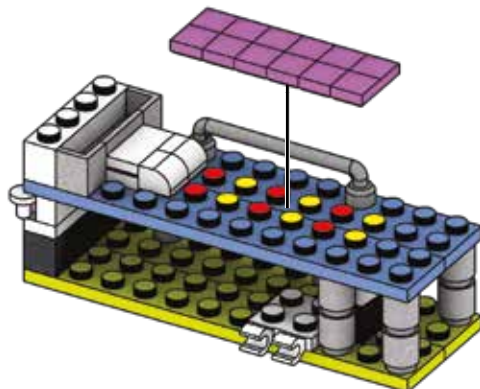





29

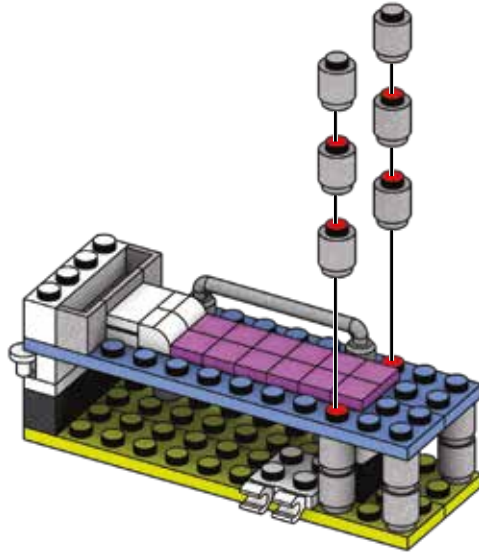

6x



30



1x



1x



2x



2x

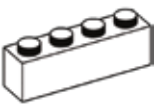

1x

1 2 3

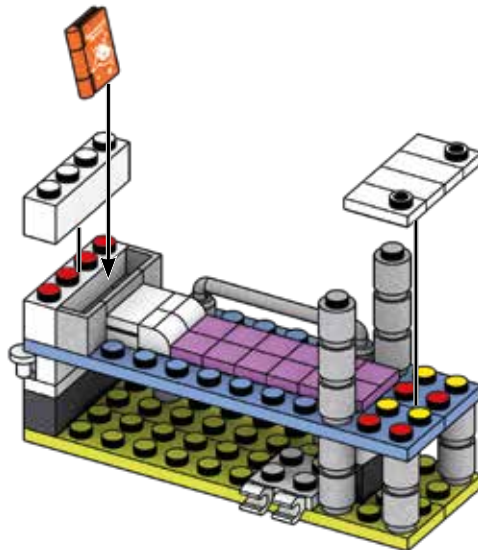



31



2x

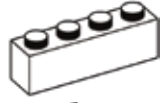

1x

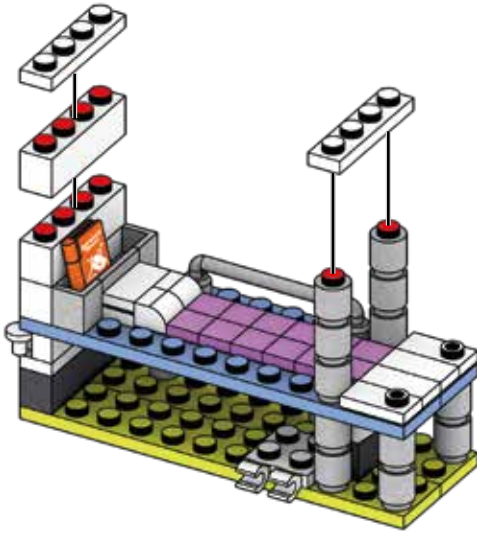

32

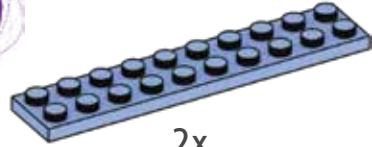

2x

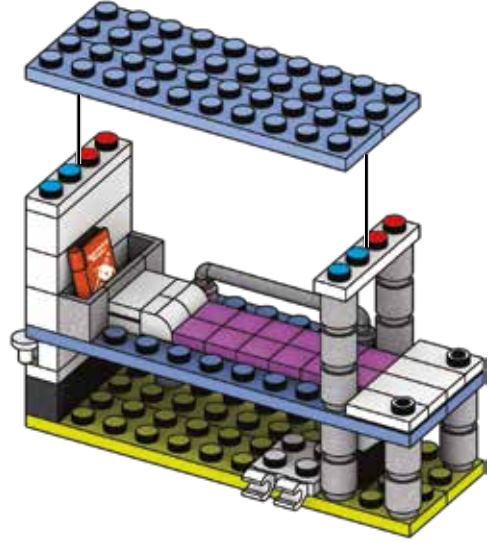

33



4x



1x



1x

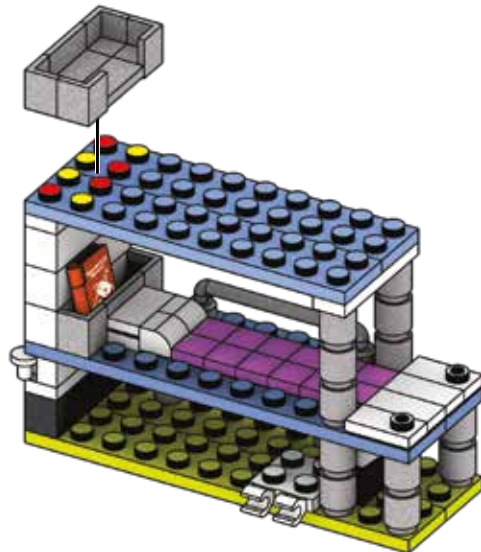



34



2x



1x



1x

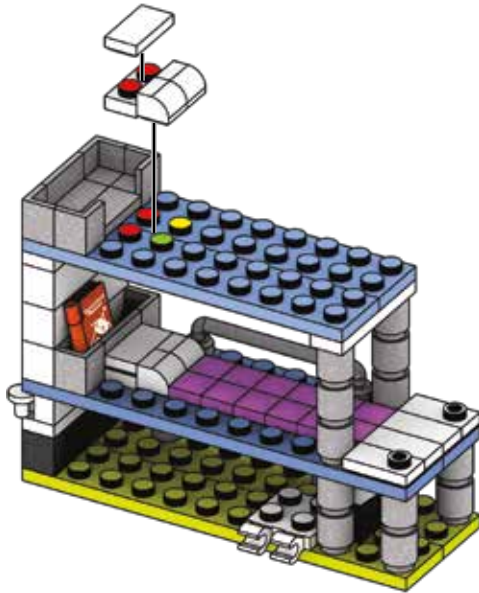

35



6x

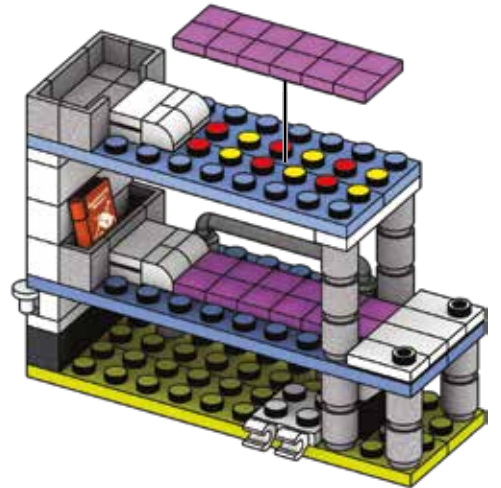

36



1x



1x

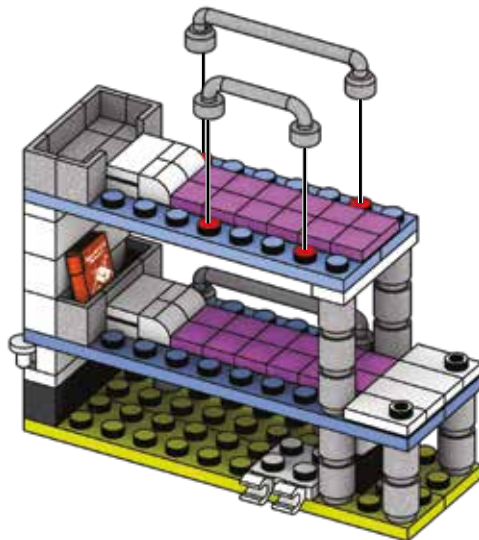



37

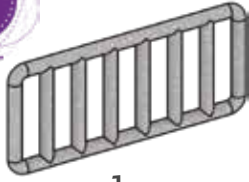

1x

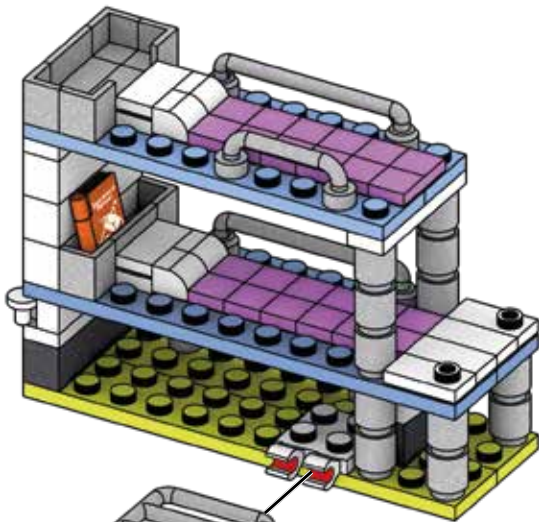

1

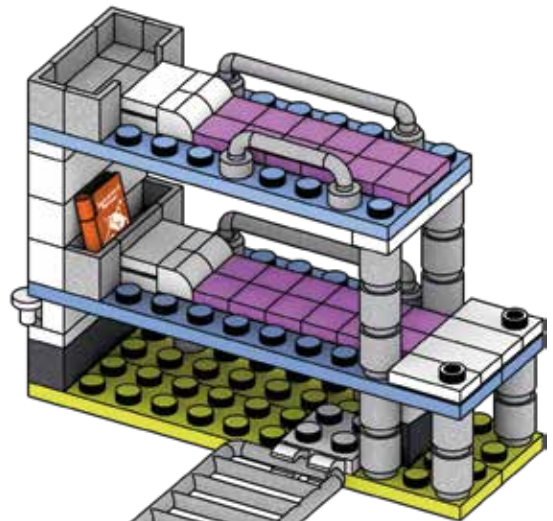

2



38



2x



3x



1x



1x



1x



1x



1x



1x



1



2



3

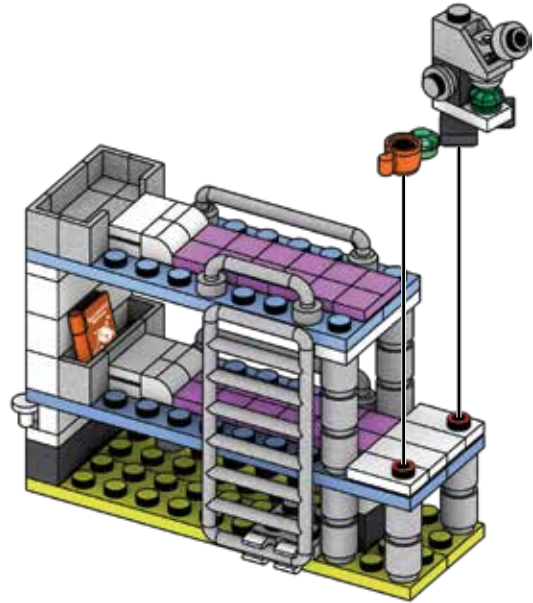

39

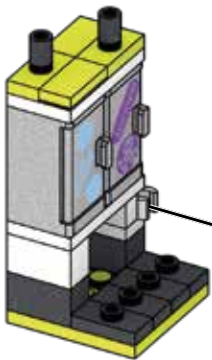

1

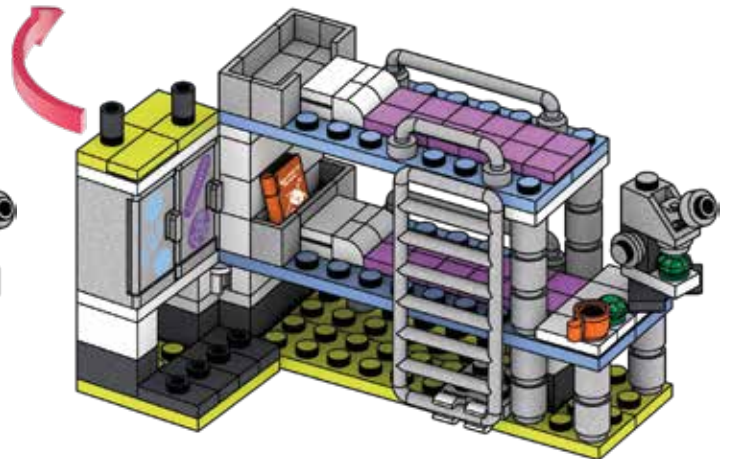

2



40



1x



1x



4x



1x



1x



1x



1x



1x



1



2



3

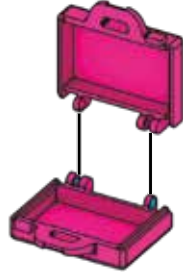

1



2



3

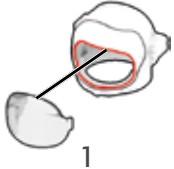

1



2

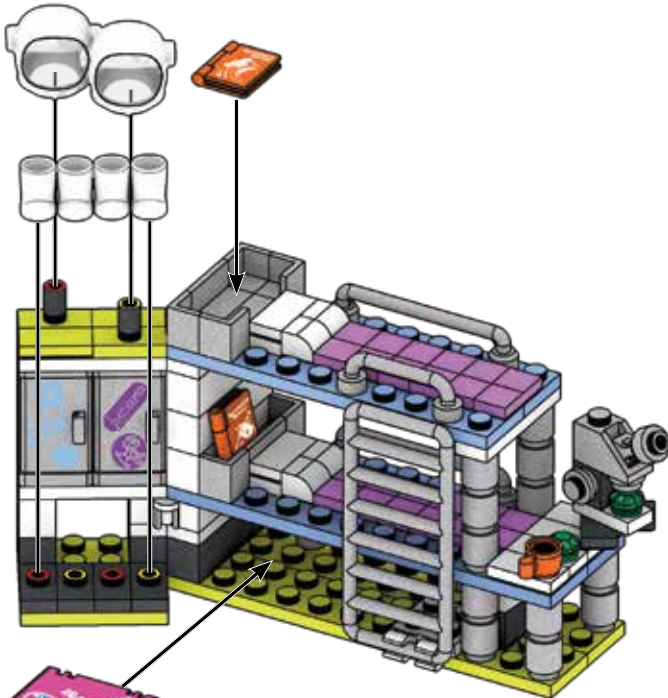

1

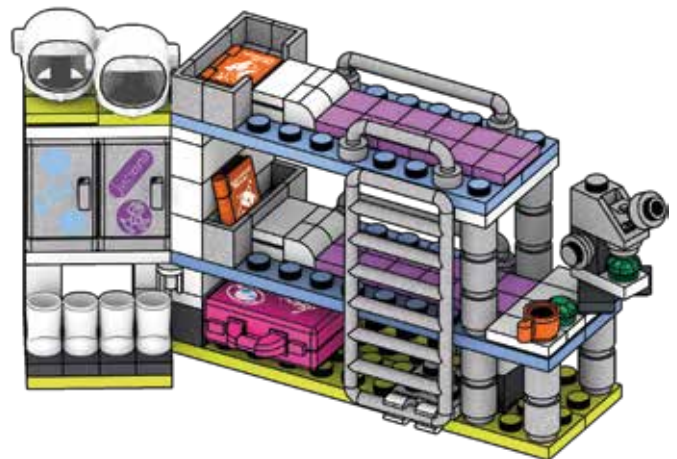

2

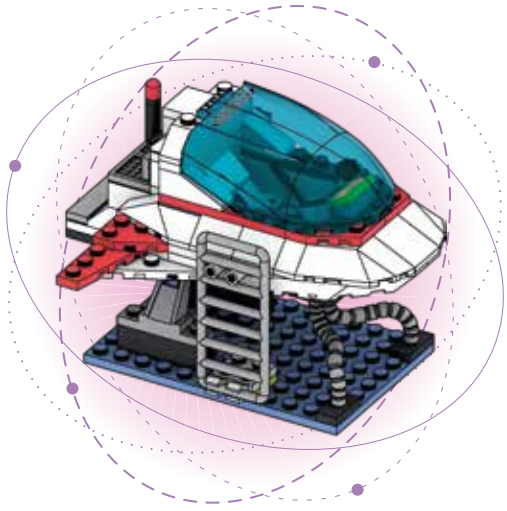

41

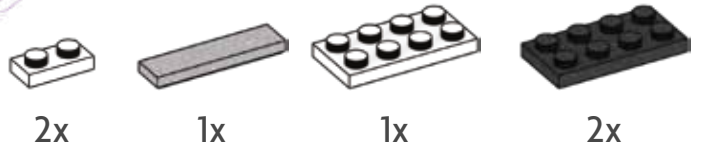

Build the mission simulator. This is where trainees practice, so they're ready for any situation.

Construit le simulateur de mission. C'est là que les stagiaires s'entraînent, afin d'être prêtes à faire face à toutes situations possibles.

Construye el simulador de misión. Aquí es donde practican los practicantes, para que estén listos para cualquier situación.

Construa o simulador de missões. É nele que os astronautas em treinamento praticam para estarem prontos para qualquer situação.

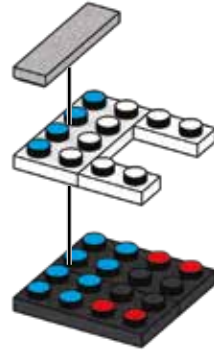

42

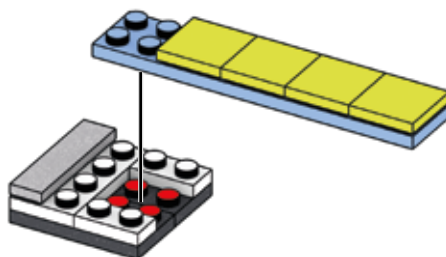
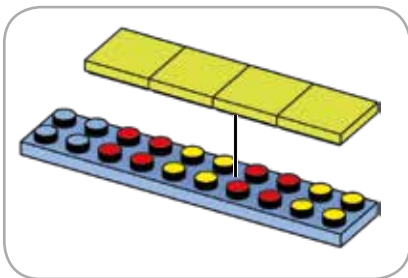
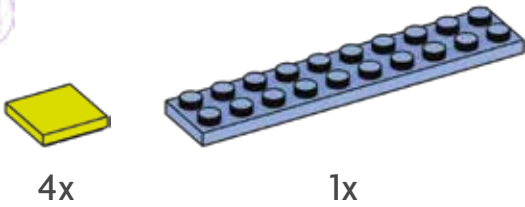



45



2x



2x



1



2

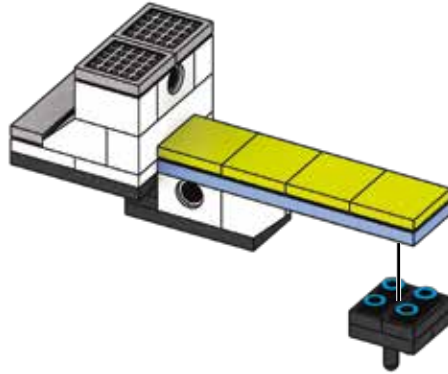

46



2x



2x



x2

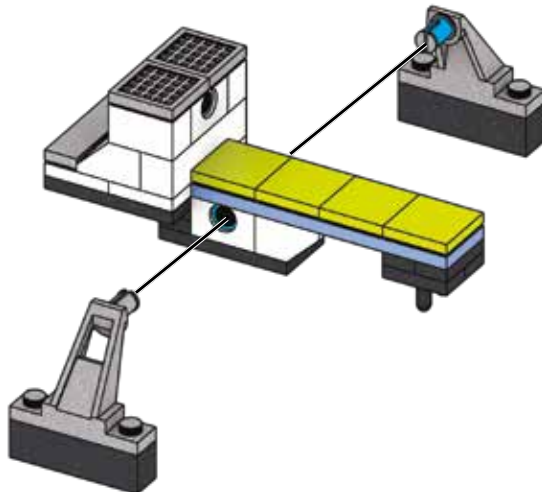



47

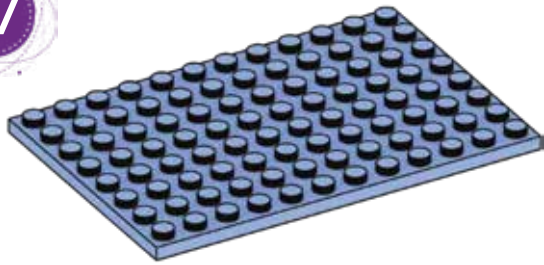

1x

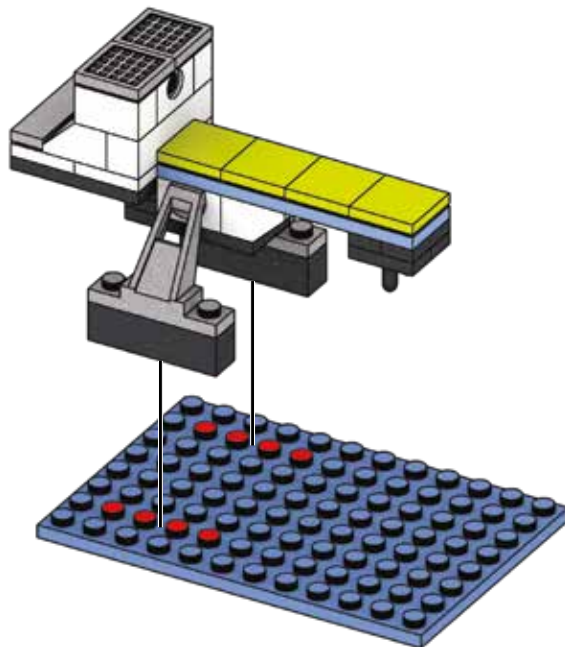

BUILDING TIP • CONSEIL UTILE CONSEJO PARA CONSTRUIR DICA DE MONTAGEM

Attach the legs carefully, one at a time.

Attache les jambes soigneusement, une à la fois.

Coloca las patas con cuidado, una a la vez.

Conecte as pernas cuidadosamente, uma de cada vez.



48



2x



2x

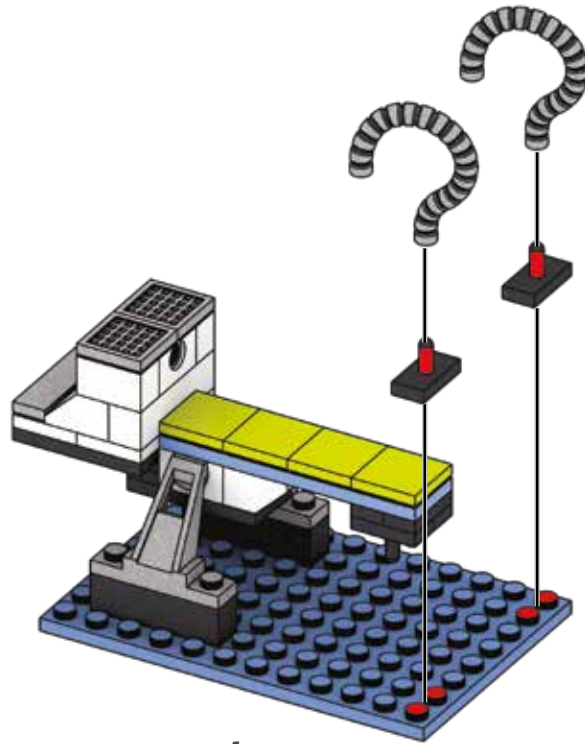

1

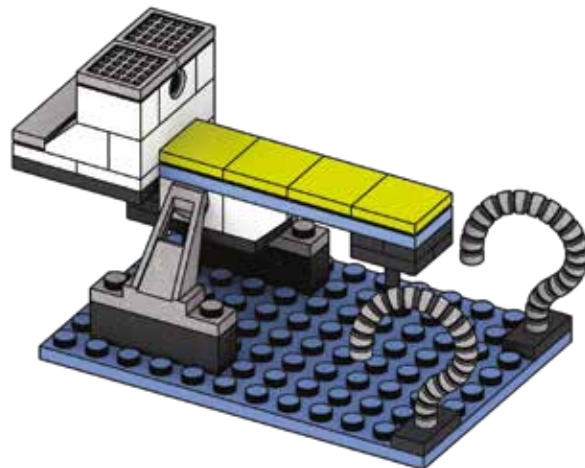

2



49

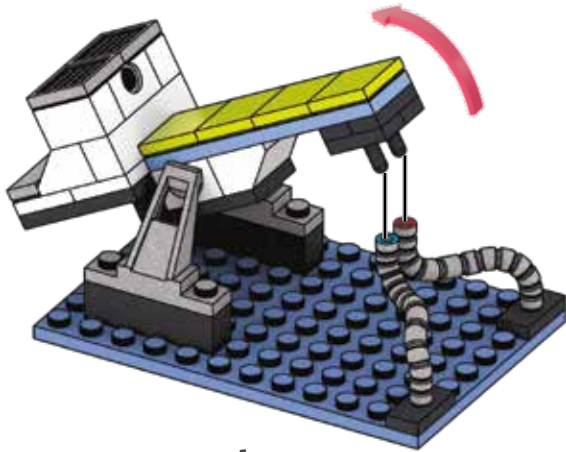

1

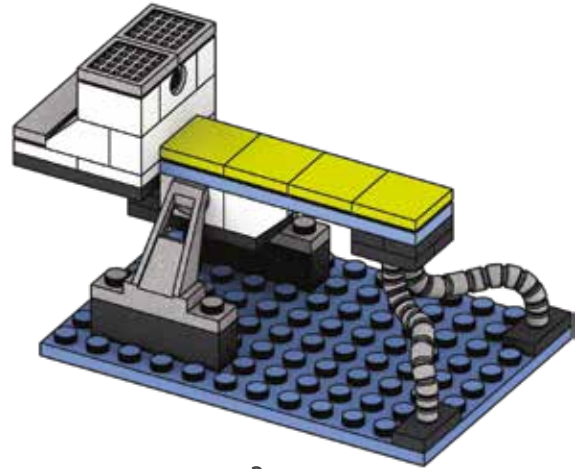

2



BUILDING TIP CONSEIL UTILE CONSEJO PARA CONSTRUIR DICA DE MONTAGEM

To attach the tubing, tilt the base up so you can see the prongs. Mission accomplished!

Pour attacher le tube, incline vers le haut la base de façon à pouvoir voir les tenons. Mission accomplie !

Para colocar las tuberías, incline la base hacia arriba para que pueda ver los dientes. ¡Misión cumplida!

Para conectar os tubos, incline a base de forma a ver os pinos. Missão completa!



50



1x



1x

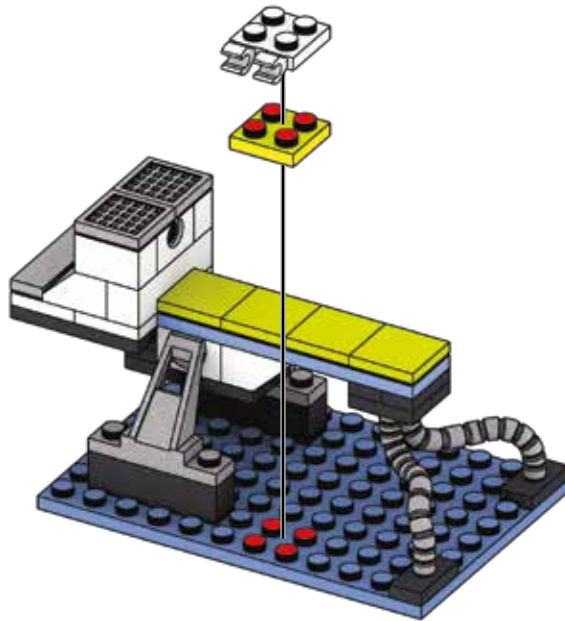

51

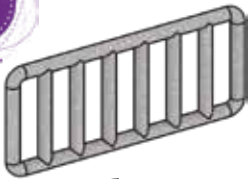

1x

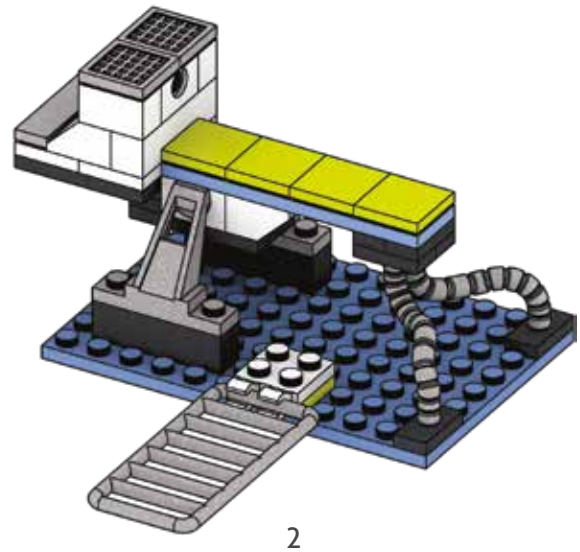
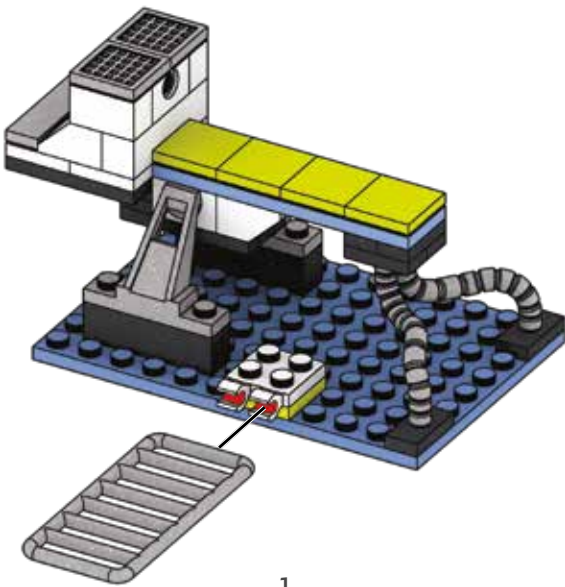



52

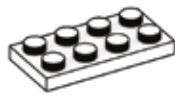

2x



1x



1x

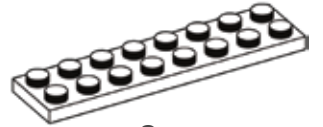

2x

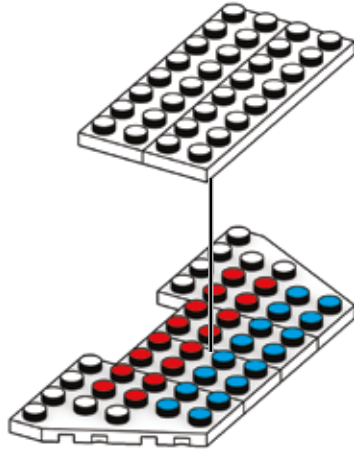

1

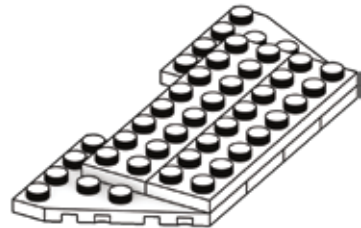

2

53



1x



1x



2x



1x

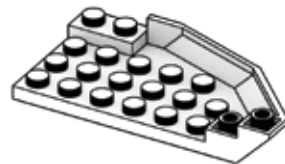

1x

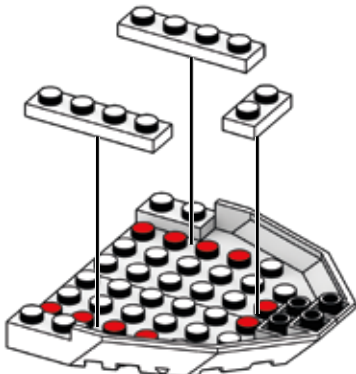

1

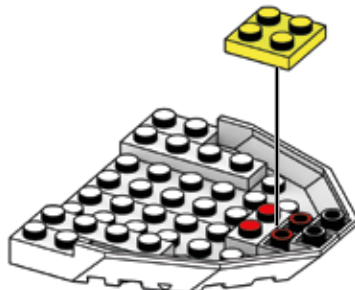

2

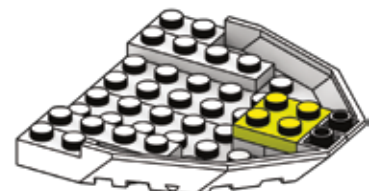

3



54

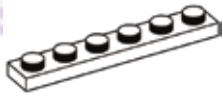

2x

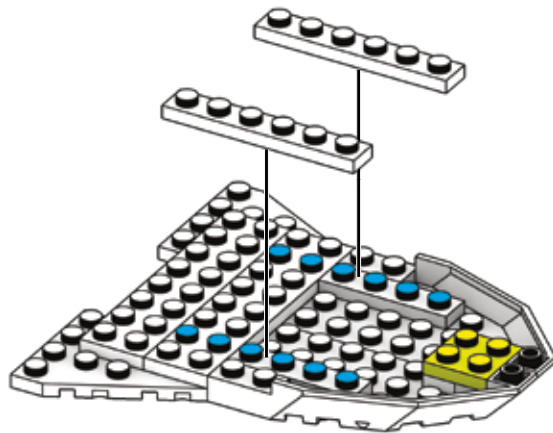

55



2x



1x



1x

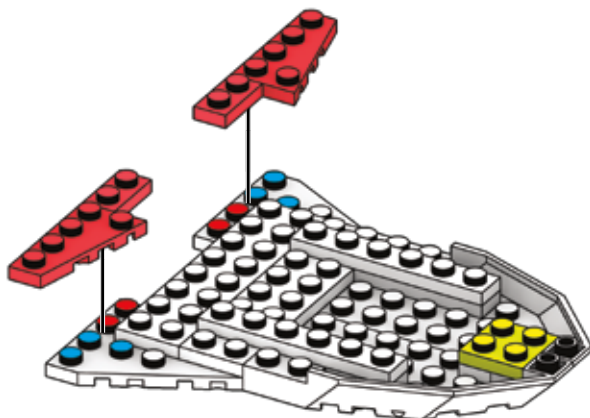



56



2x



1x



1x



1x



1x

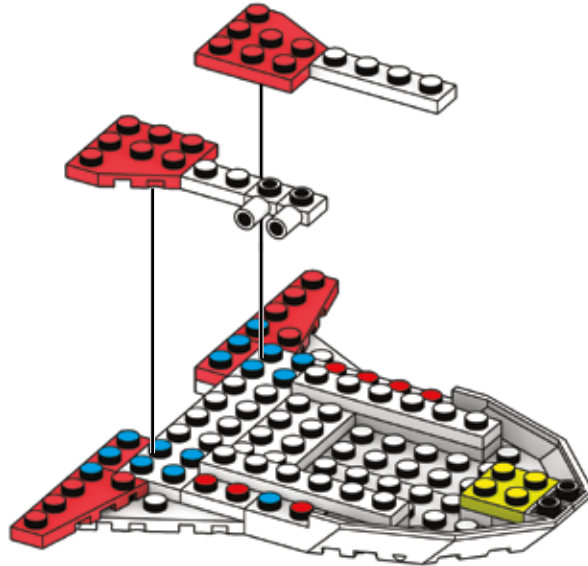

57



1x



1x



3x



1



2

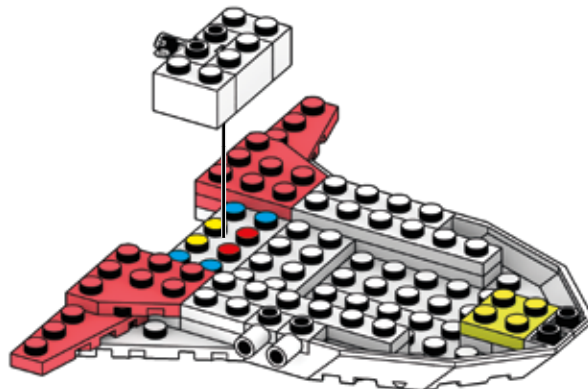



58



2x



1x

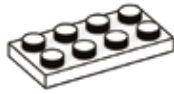

1x

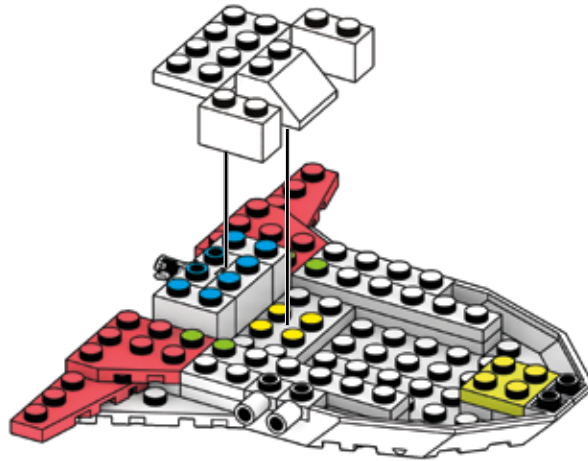

59



1x



1x

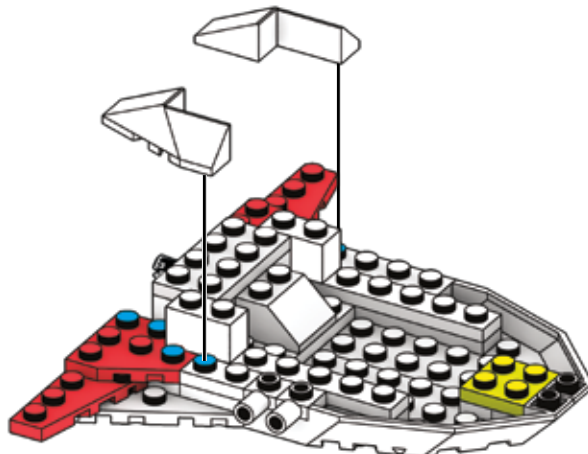



60



4x



2x

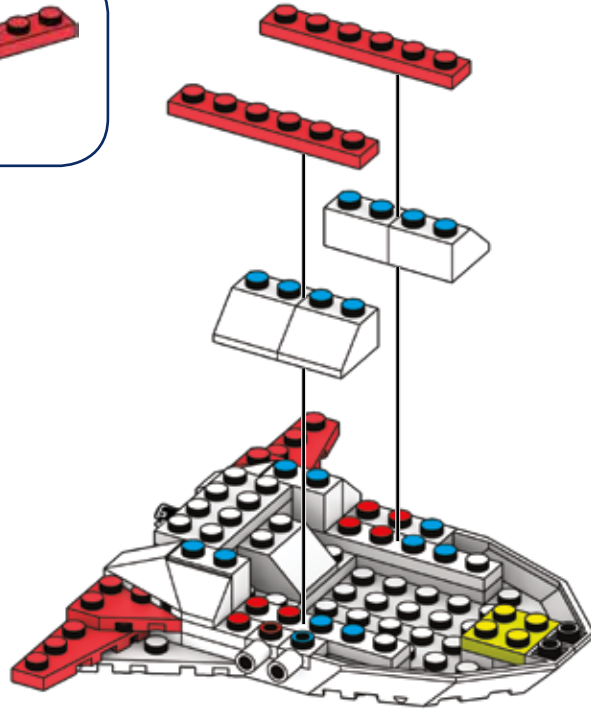

61



2x



2x

x2

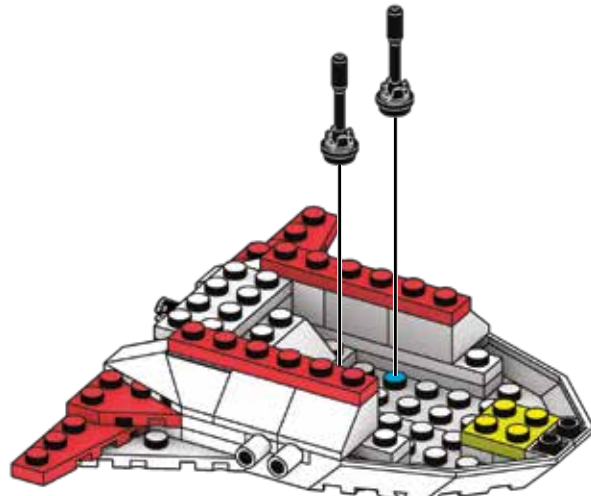



62

2x

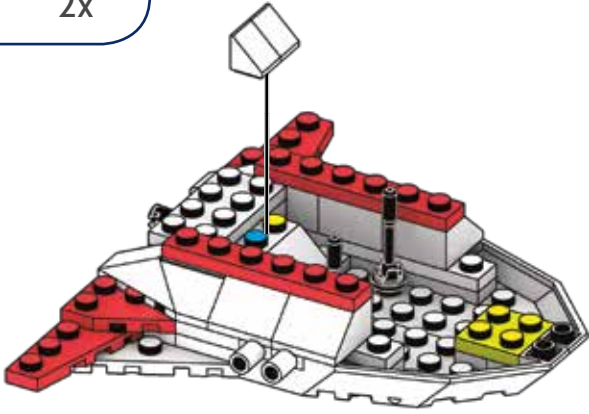

1

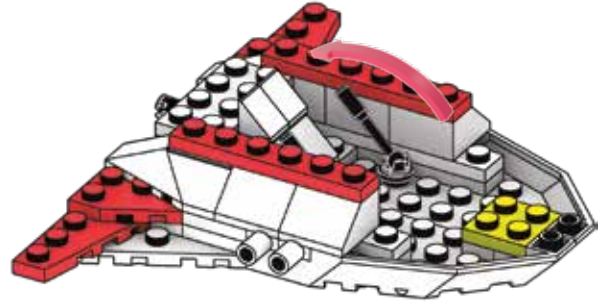

2

63



1x



1x



1x



1x



1x

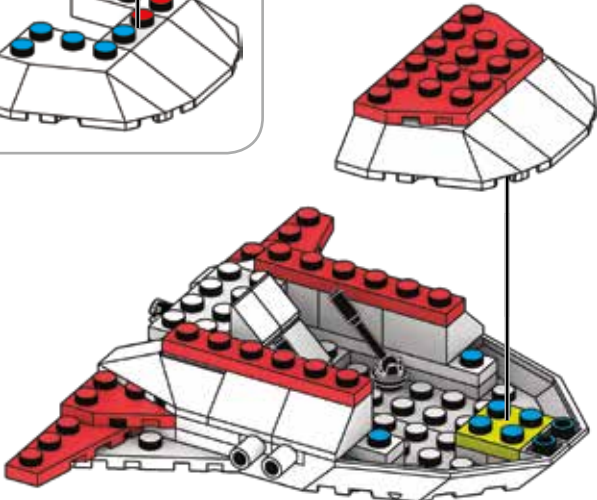
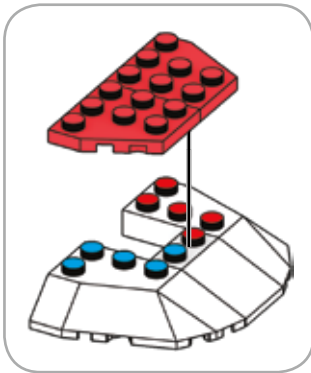

1

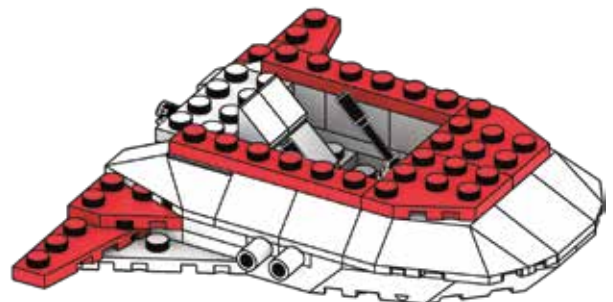

2



64



1x



2x

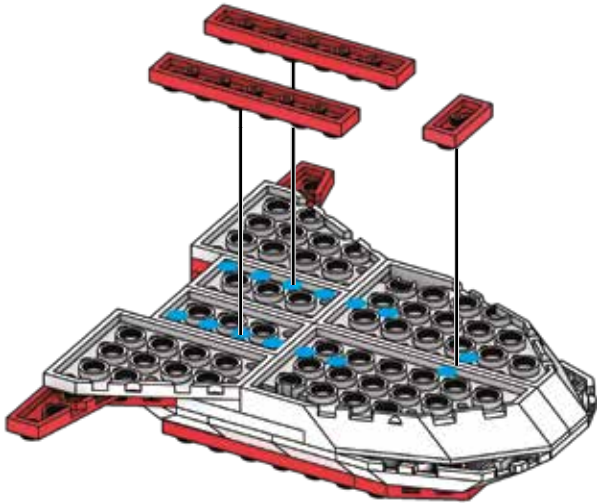

1

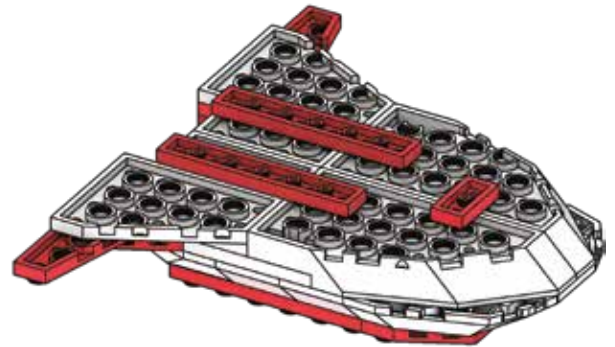

2



BUILDING TIP • CONSEIL UTILE CONSEJO PARA CONSTRUIR DICA DE MONTAGEM

Flip the bottom of the capsule over to connect the bricks. Good job!

Retourne la base de la capsule à l'envers pour y attacher les blocs. Bon travail !

Voltea la cápsula para colocar los bloques. ¡Buen trabajo!

Vire a cápsula de cabeça para baixo para conectar os blocos. Bom trabalho!



65



2x



3x



1x



1x



1x

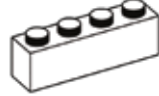

1x



1



2

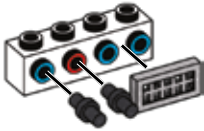

1

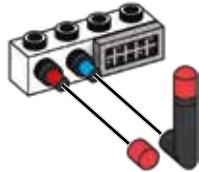

2



3

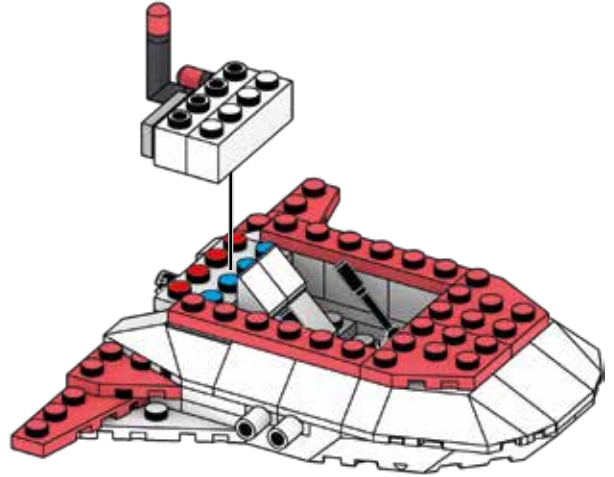

66

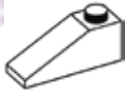

2x



1x

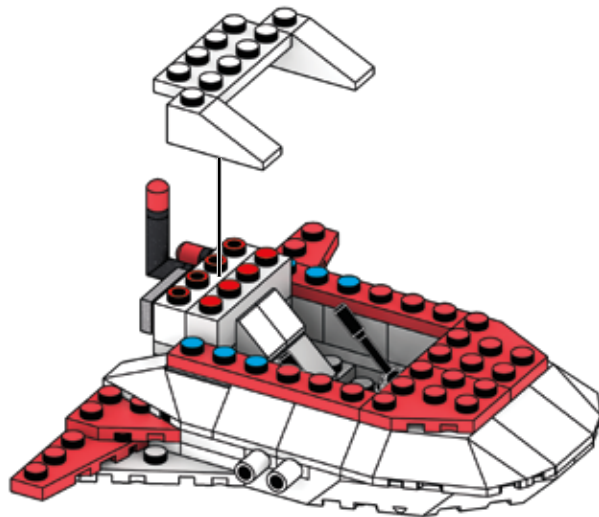



67



2x



2x

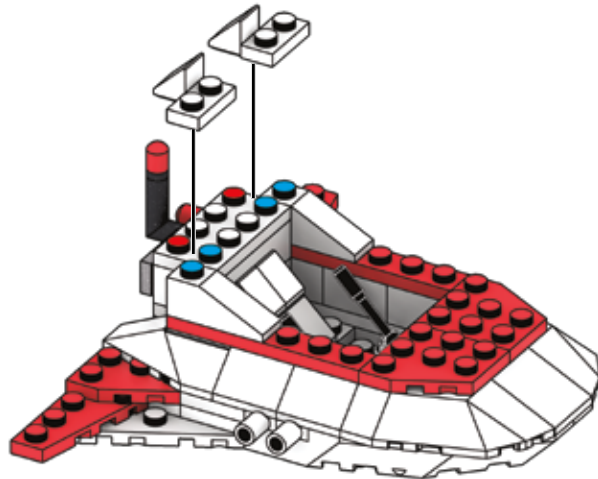

68



2x

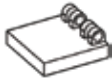

1x



1x

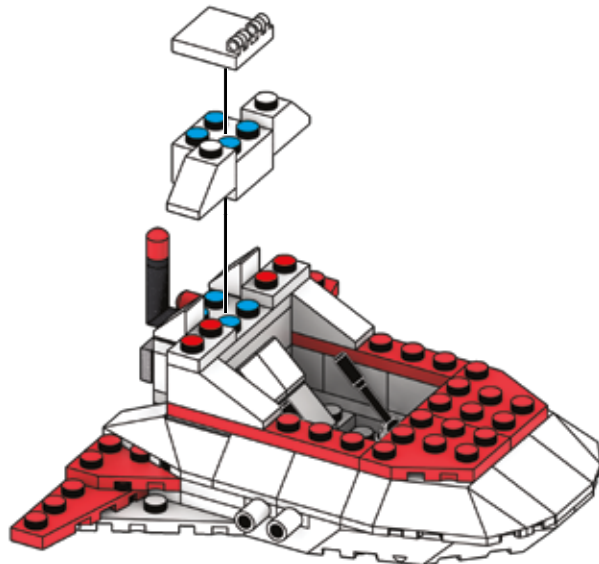



69

- 1x
- 1x
- 2x
- 1x
- 1x

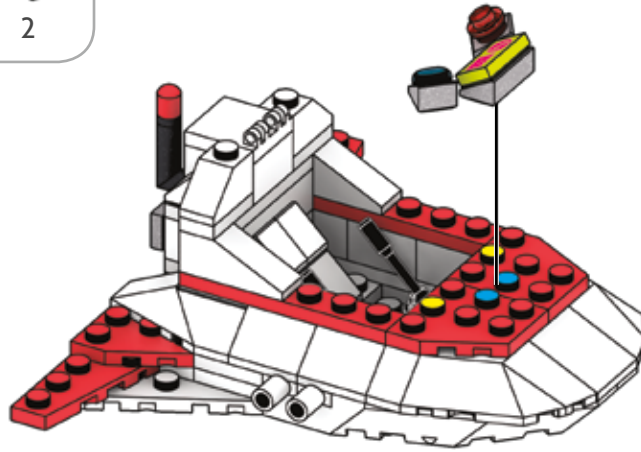
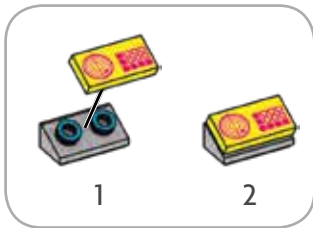
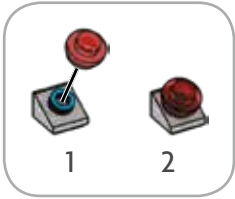
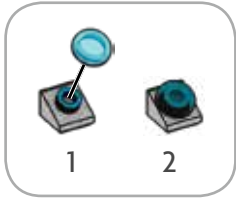

70

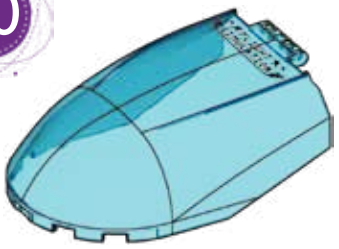

1x

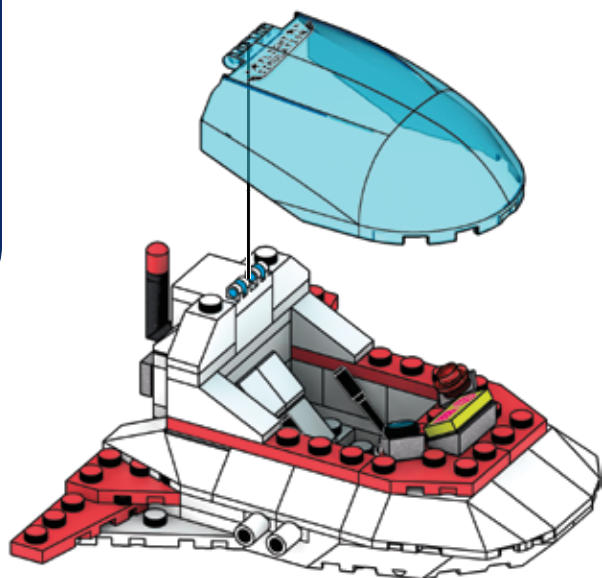



71

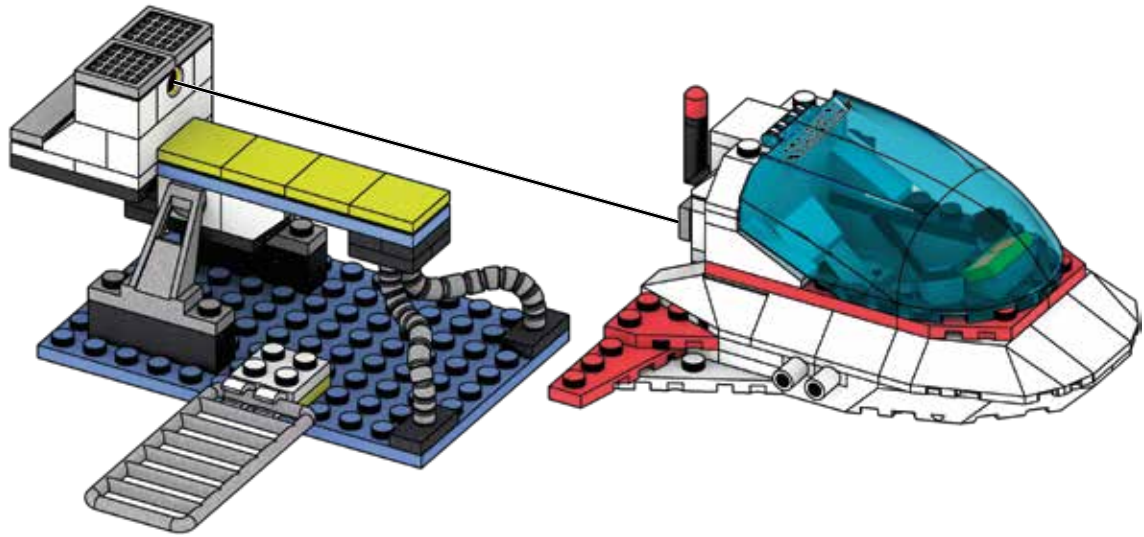

BUILDING TIP • CONSEIL UTILE CONSEJO PARA CONSTRUIR DICA DE MONTAGEM

To remove the capsule, hold the back of the base with one hand, and use your other hand to slide the capsule off.

Pour retirer la capsule, maintien l'arrière de la base avec une main et utilise l'autre main pour faire glisser la capsule.

Para remover la cápsula, sostén la parte posterior de la base con una mano, y usa tu otra mano para deslizar la cápsula.

Para remover a cápsula, segure a parte de trás da base com uma mão e use a outra mão para deslizar a cápsula fora da base.



72

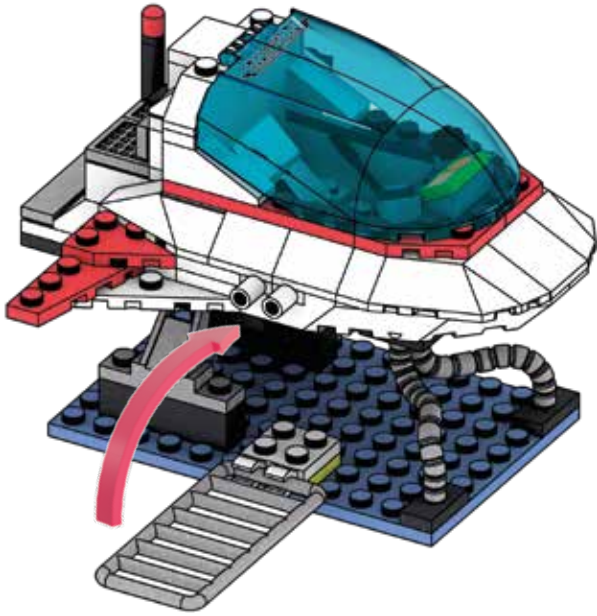

1

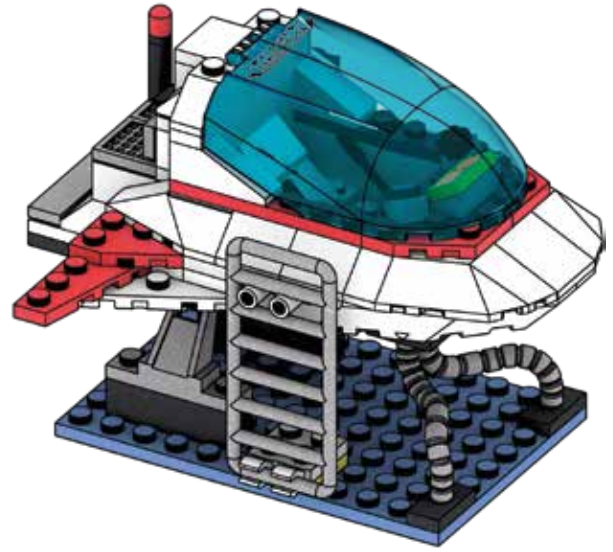

2

BUILDING TIP • CONSEIL UTILE CONSEJO PARA CONSTRUIR DICA DE MONTAGEM

To unlock the capsule from its base, gently pull down the ladder. To lock the capsule back up, press the ladder back into place.

Pour retirer la capsule de sa base, pousse doucement l'échelle vers le bas. Pour remettre la capsule sur ça base, replace l'échelle en place.

Para separar la cápsula de su base, retira delicadamente la escalera. Para volver a unir la cápsula a su base, coloca la escalera de nuevo en su lugar.

Para desbloquear a cápsula da base, empurre a escada para baixo. Para bloquear novamente, pressione a escada de volta em seu lugar.

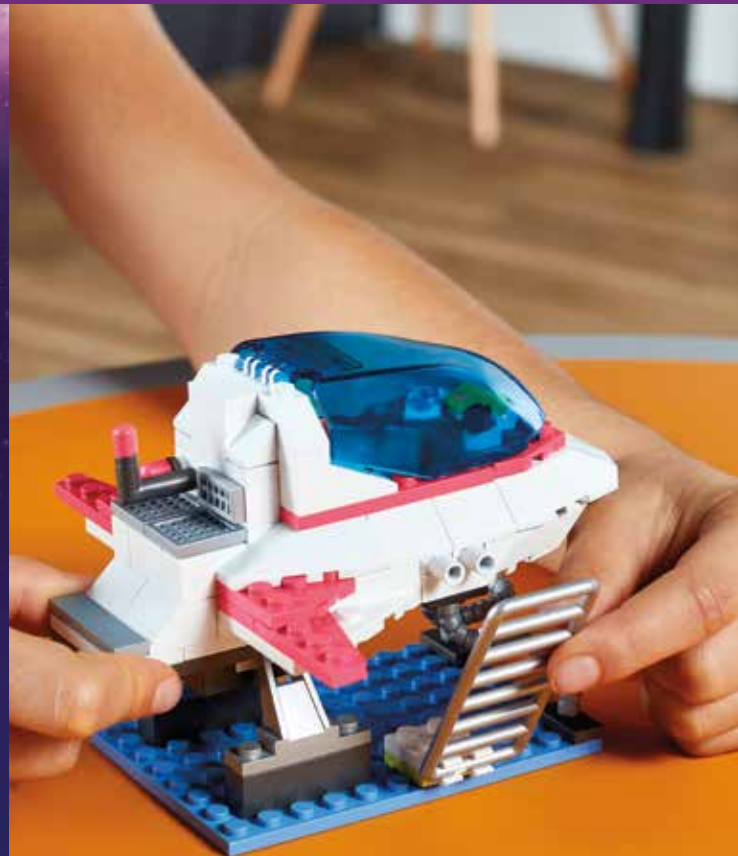

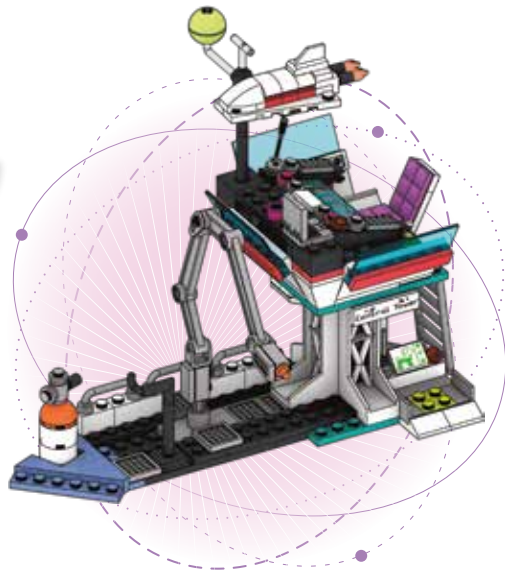

From mission control, trainees communicate with their partners in the simulator. "Capsule crew, do you copy?" says Luci. "Launch ready in T-minus one minute and counting."

À partir du centre de contrôle, les apprentis communiquent avec leurs coéquipiers dans le simulateur. « Équipage de bord, vous me recevez ? » dit Lucy. « Préparez-vous pour le décollage, le compte à rebours d'une minute est commencé. »

Desde el control de misión, los alumnos se comunican con sus supervisores en el simulador. "La tripulación de la cápsula, ¿tú copias?", Dice Luci. " Lanzamiento listo en T menos un minuto y contando".

Do controle de missão, os astronautas em treinamento comunicam com seus colegas no simulador. "Equipe da cápsula, vocês estão ouvindo?", diz Luci. "Contagem regressiva para o lançamento em um minuto."

73



3x



1x

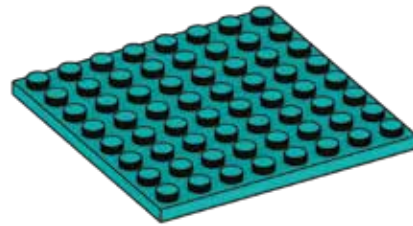

1x

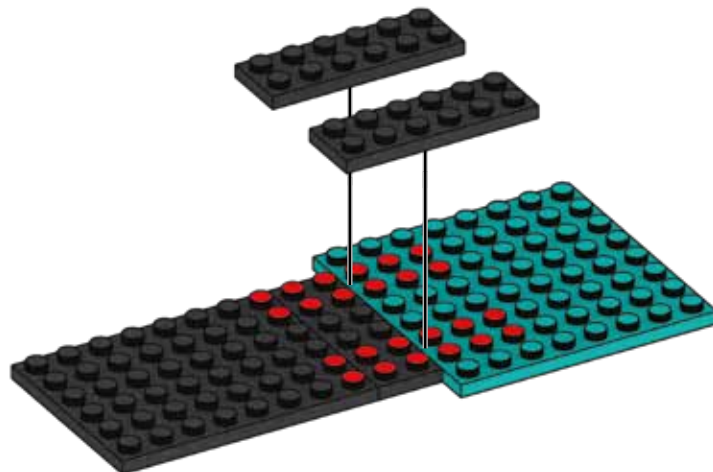



74



2x



1x



1x

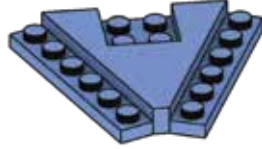

1x

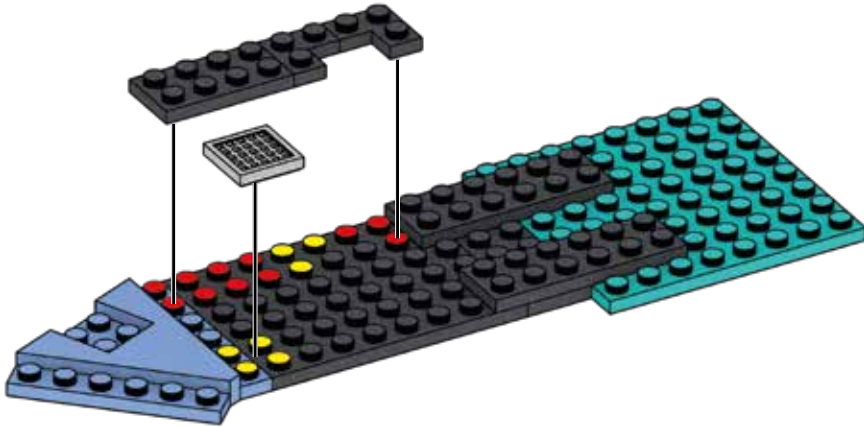

75



1x



2x



1x

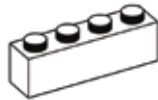

1x





76



1x

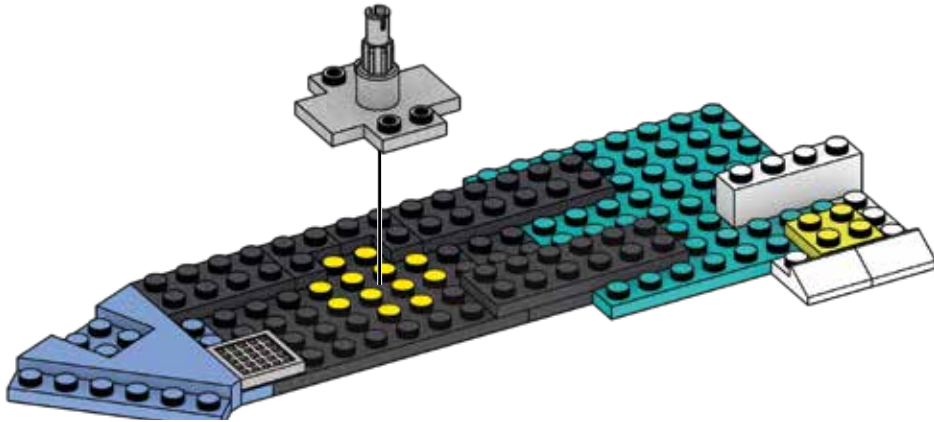

77



2x

1x

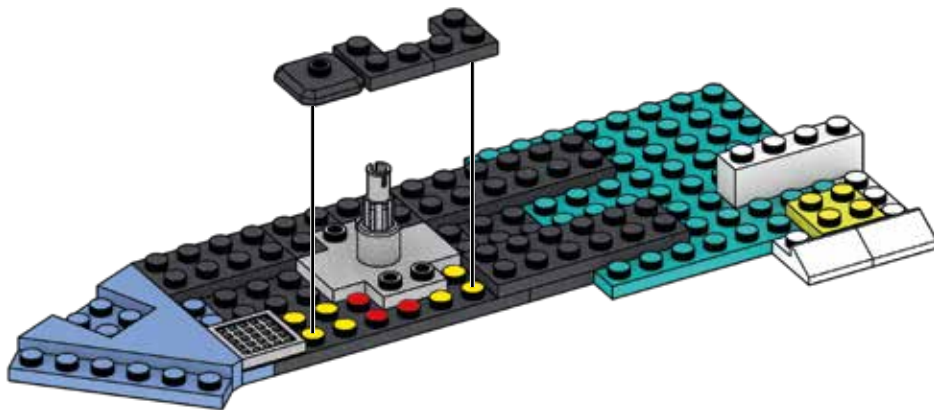



78



2x



1x



79



1x



1x



1x



1x



3x

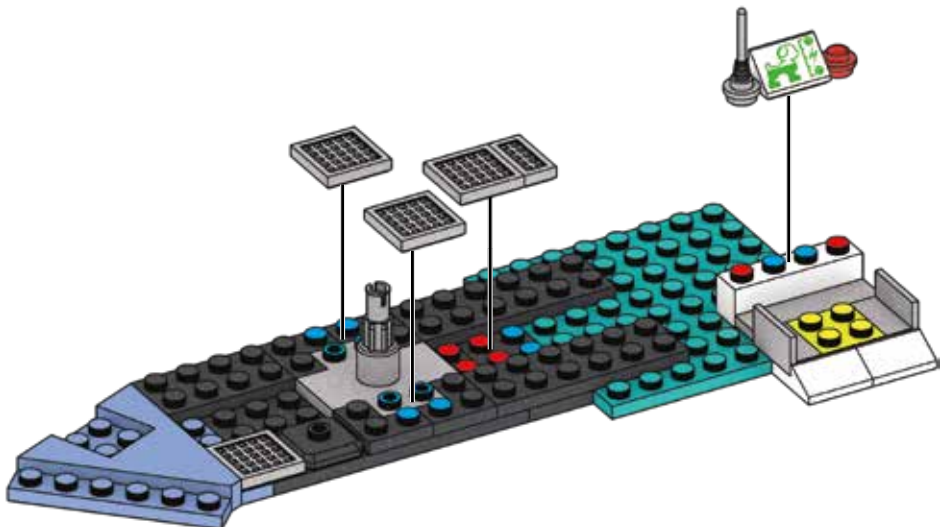



80



2x



3x

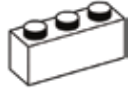

2x

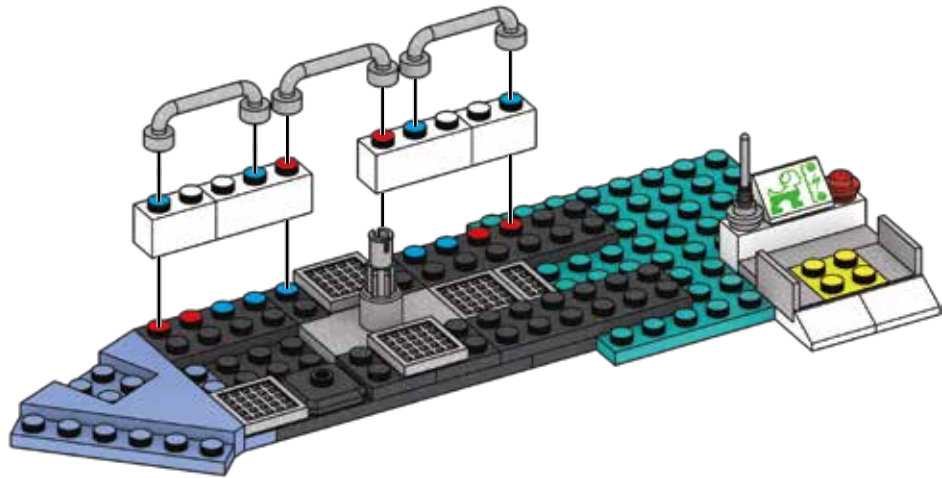

81

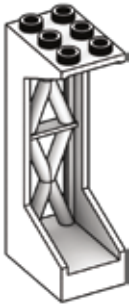

4x

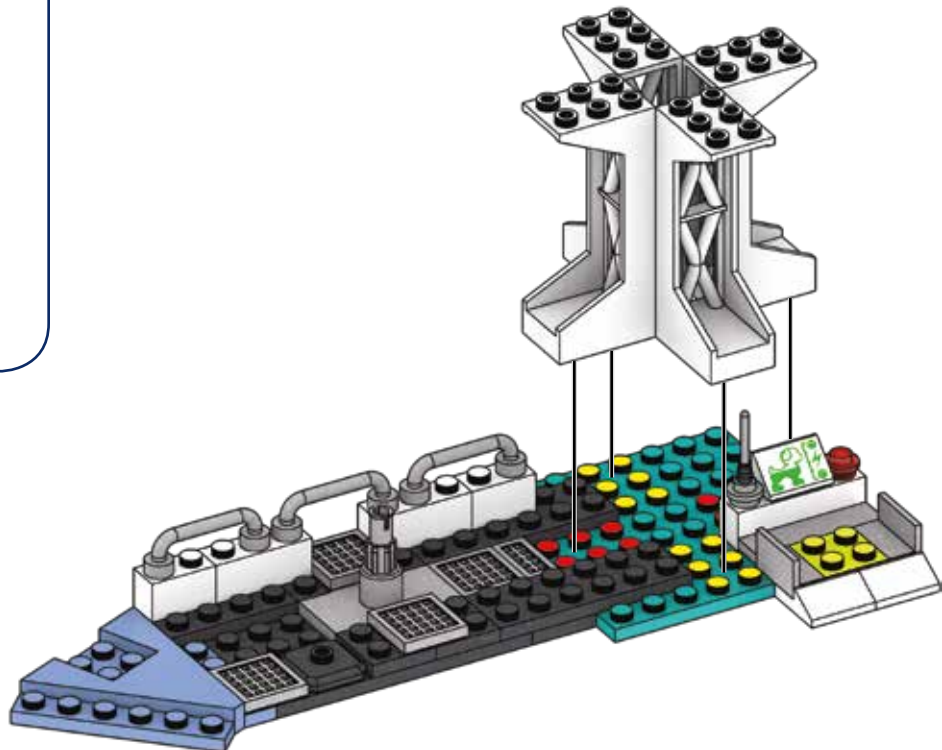



82



2x



1x



1x

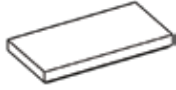

2x

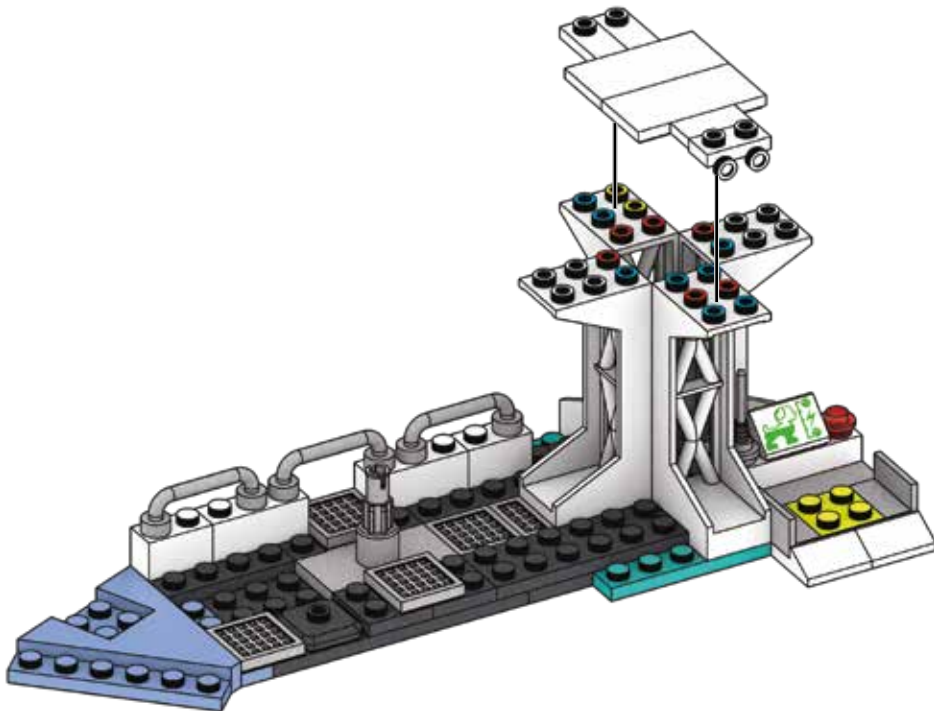



83



2x



1x



1x

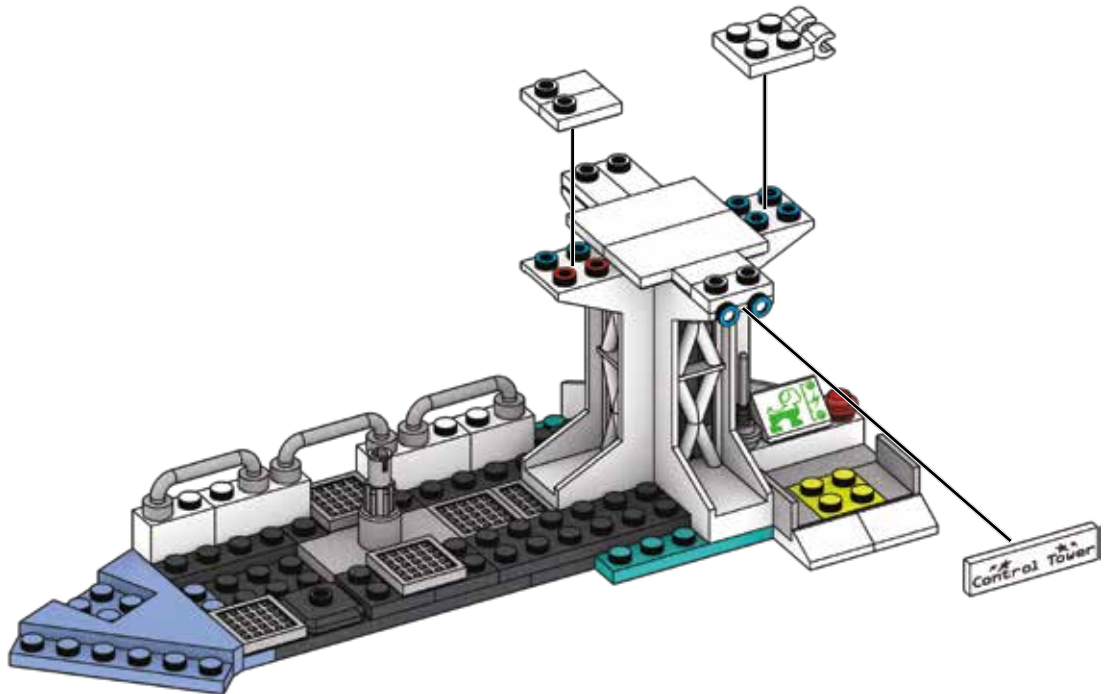



84



2x



1x



1x



1x



2x

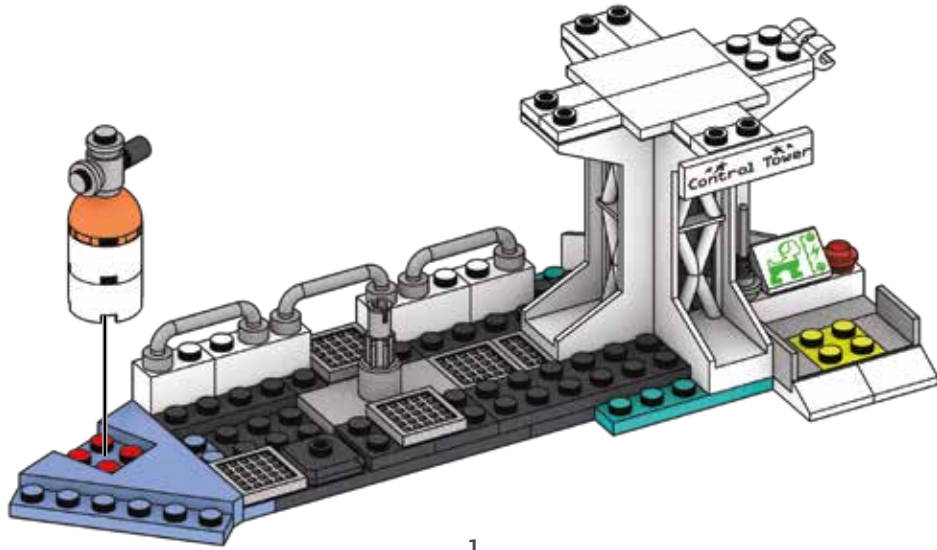
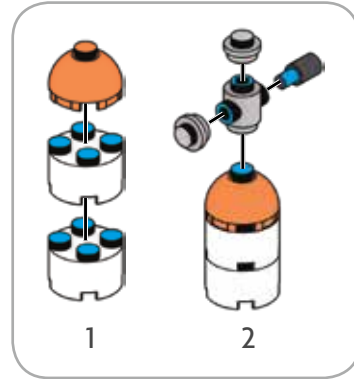

1

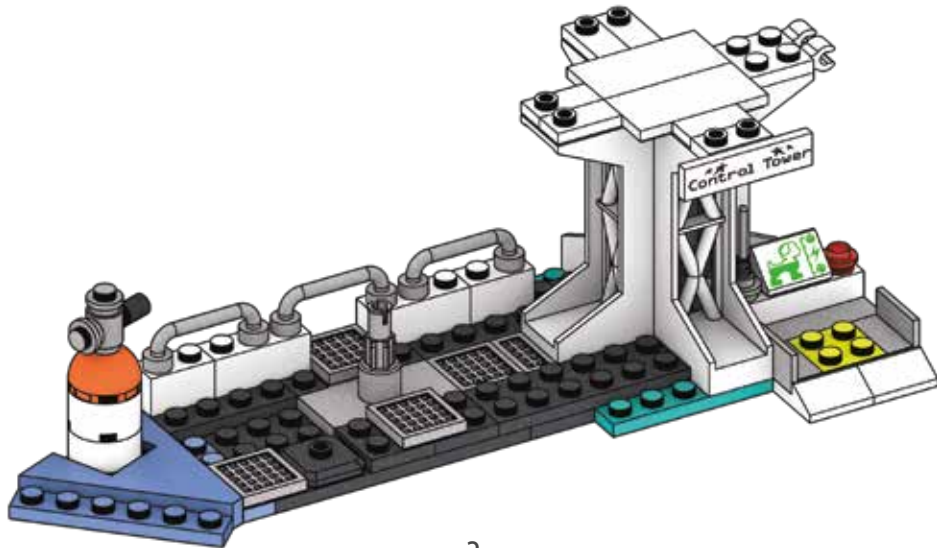

2



85

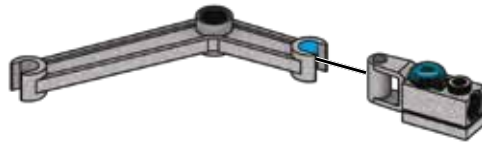
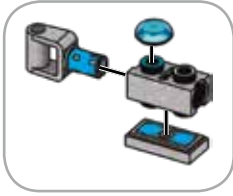
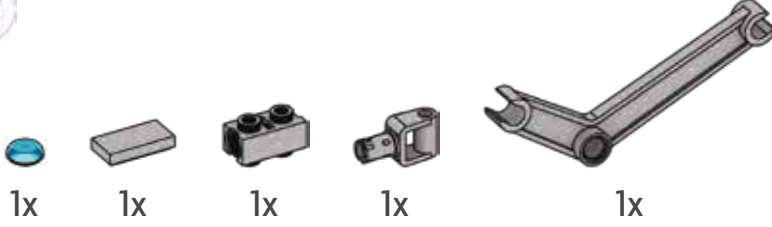

86

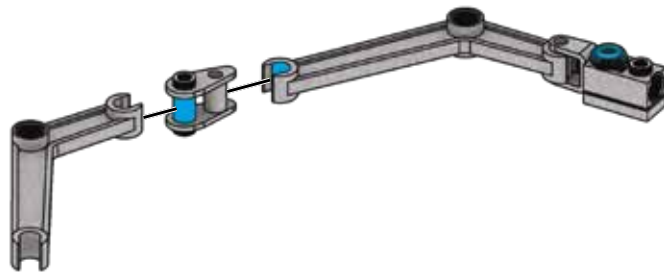
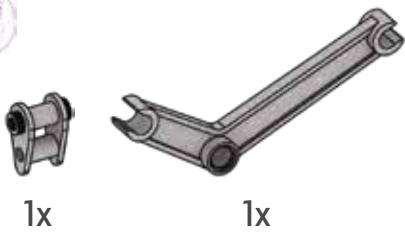



87



1x



1x



1x



1x

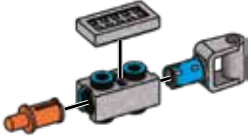

1



2

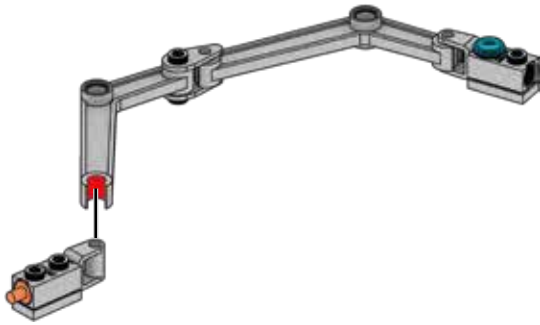

1

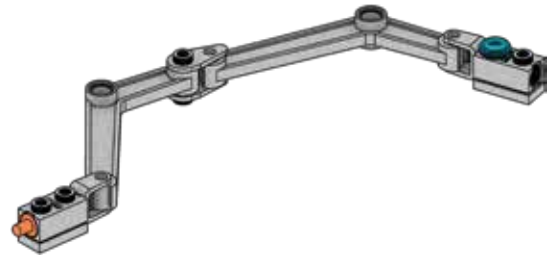

2

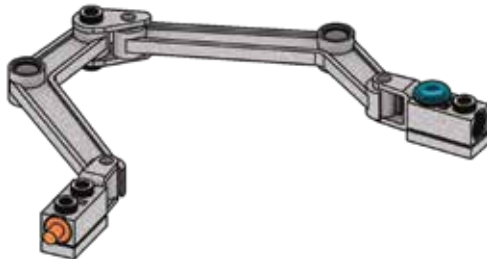

3

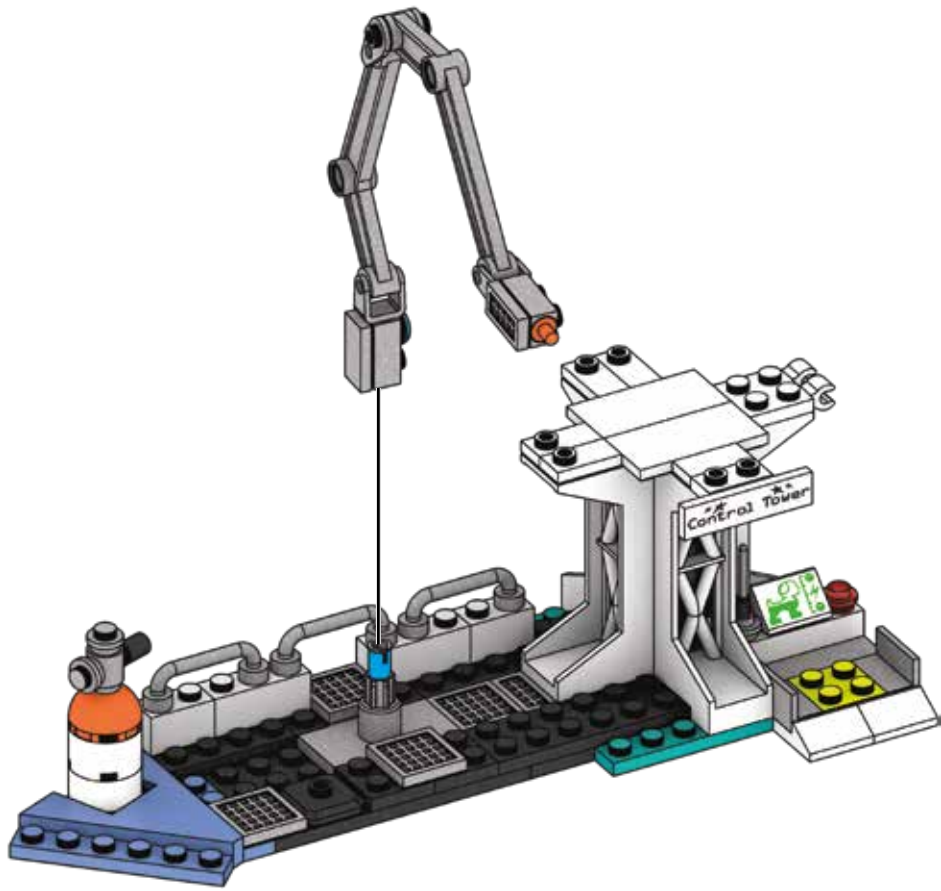



88

2x



1x



1x



1x

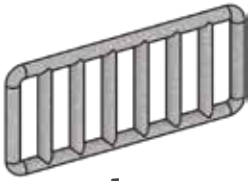

1x

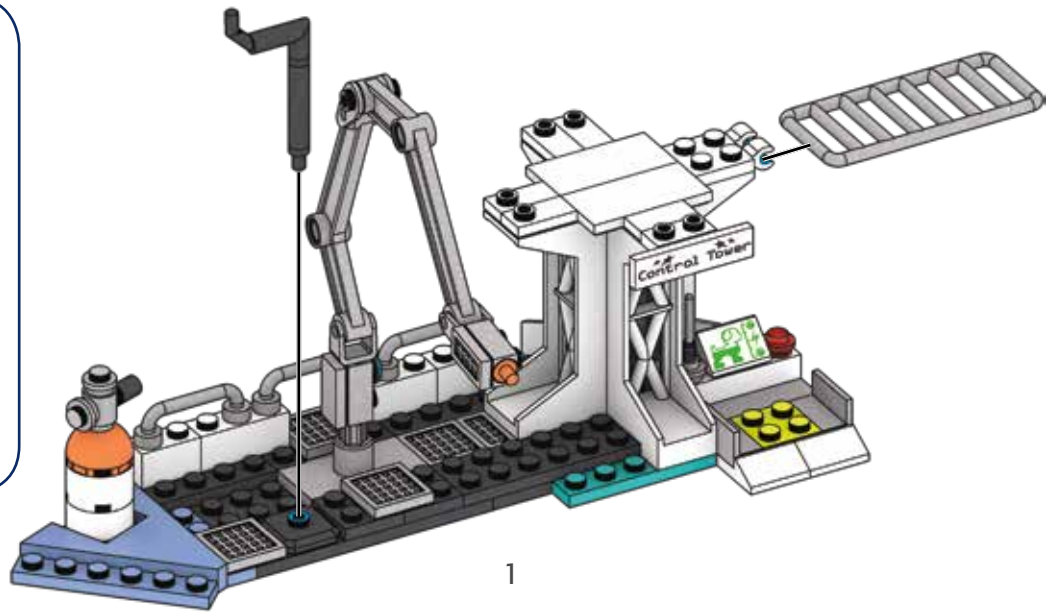

1



1

2

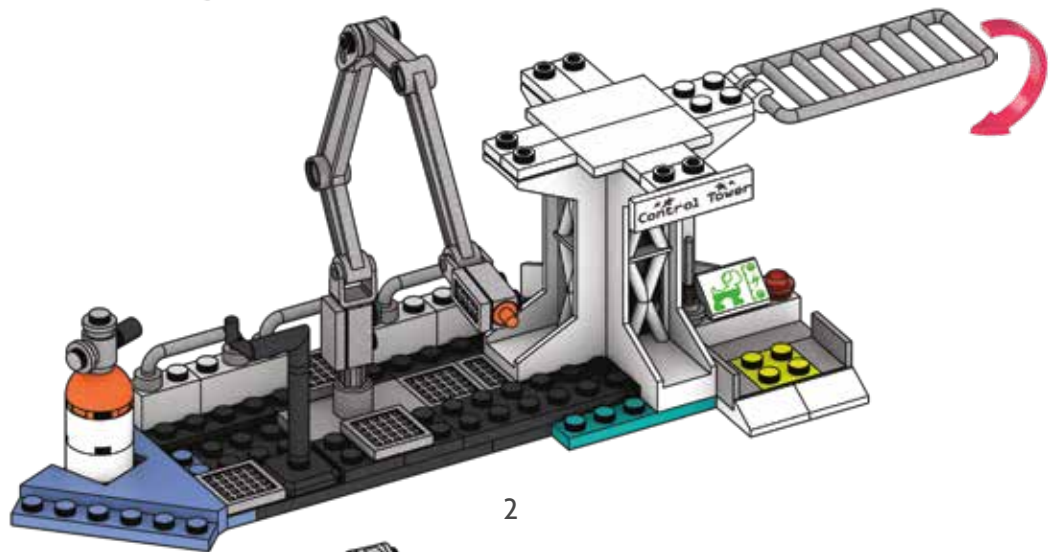

2

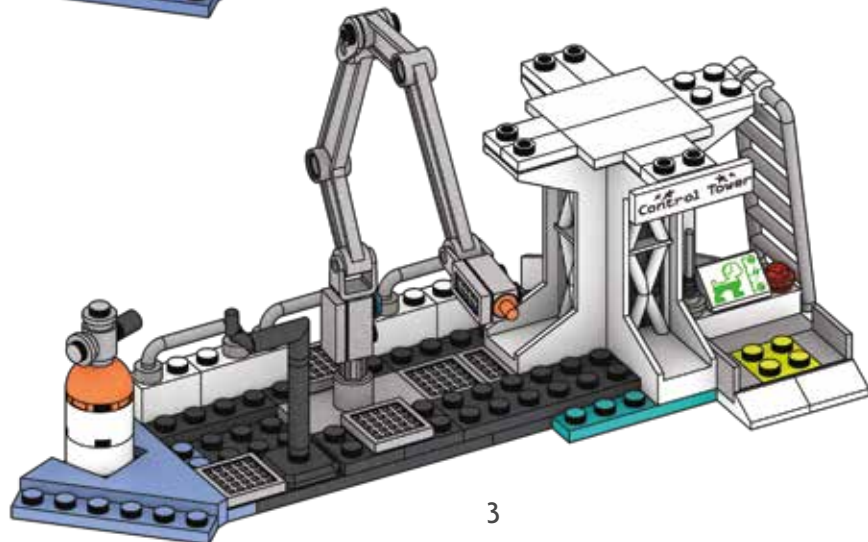

3



89

2x 

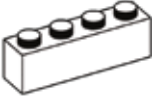
2x 

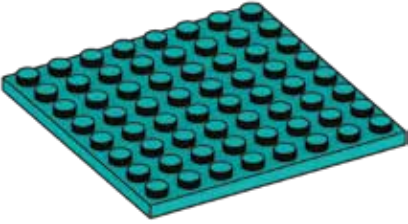
1x 

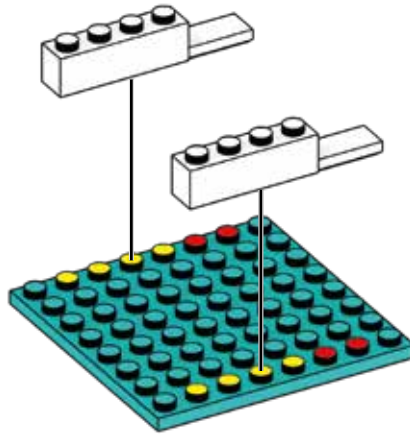

90

1x 

1x 

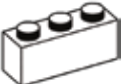
2x 

2x 

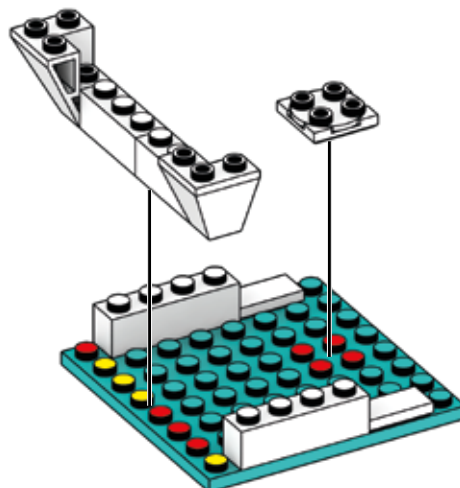



91



2x

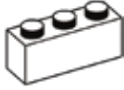

2x

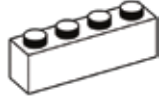

1x

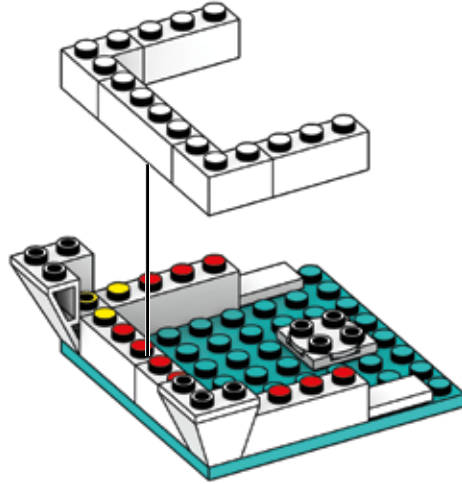

92



2x



3x

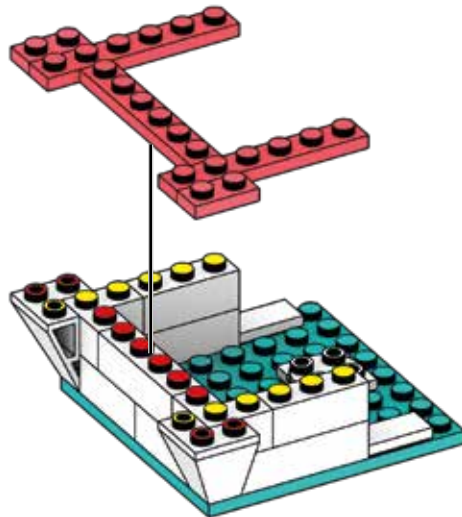



93

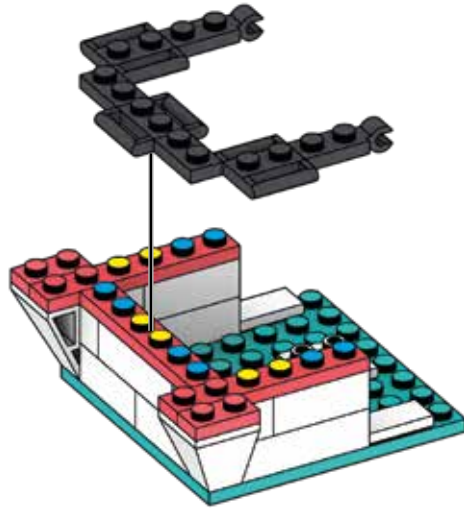

94

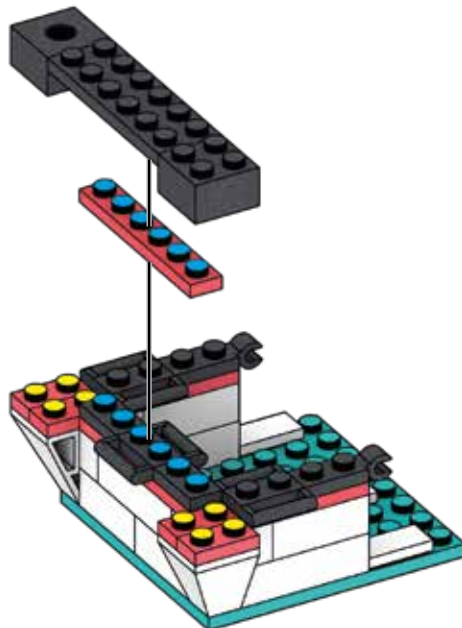
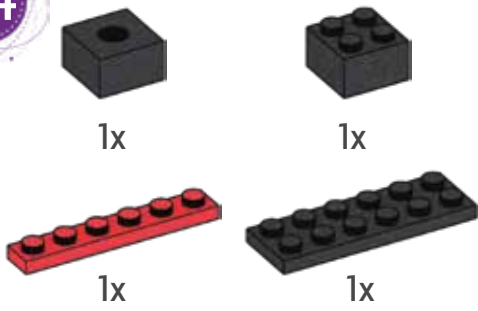



95

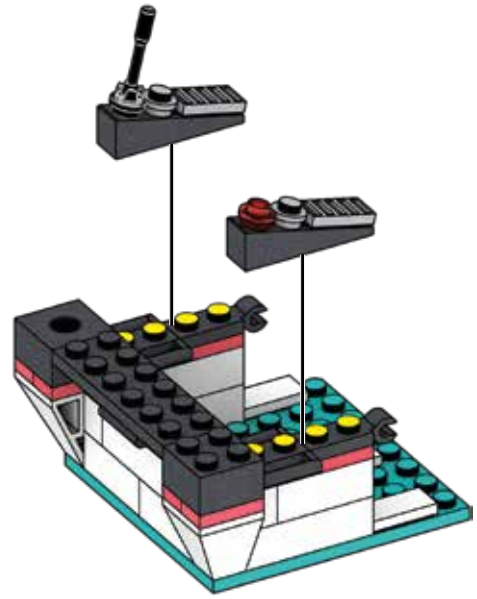



96



1x



1x



1x



1x

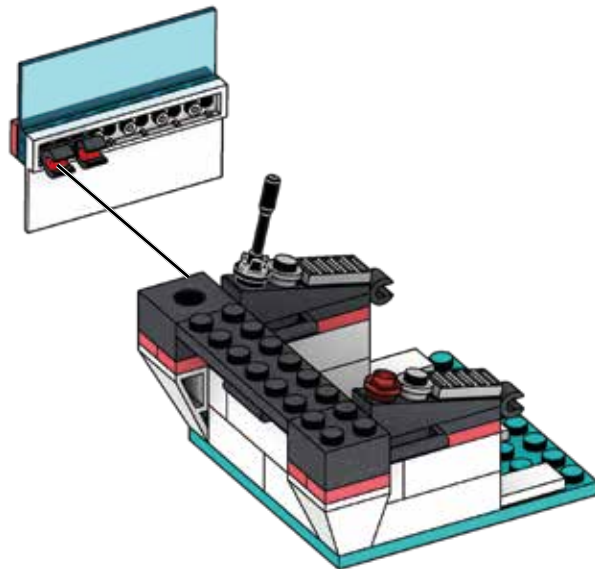
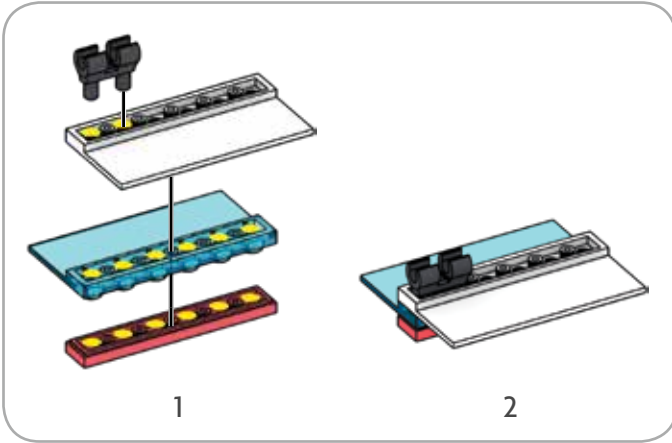



97



1x



1x



1x



1x

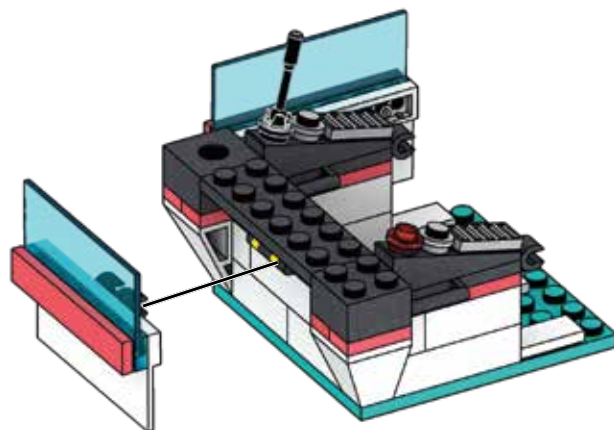
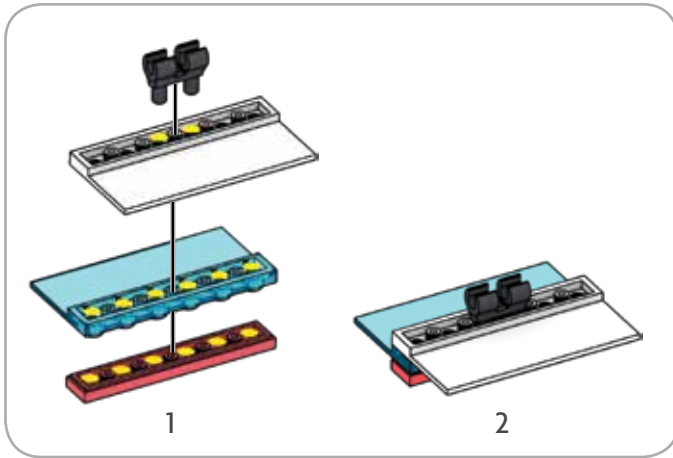



98



1x



1x



1x



1x

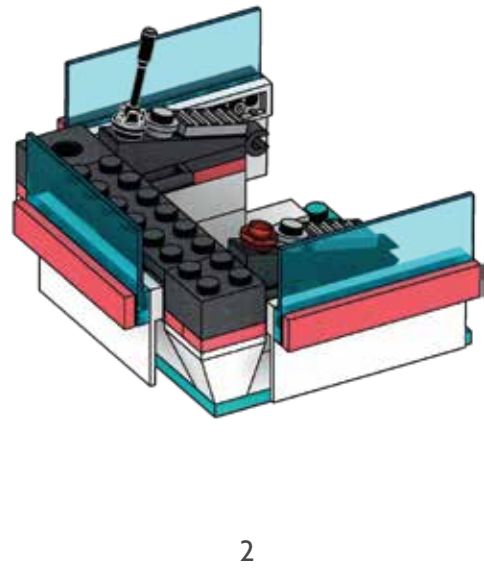
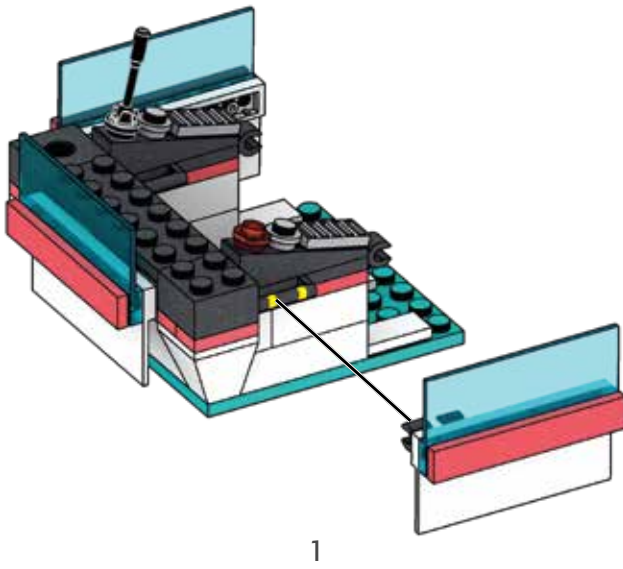
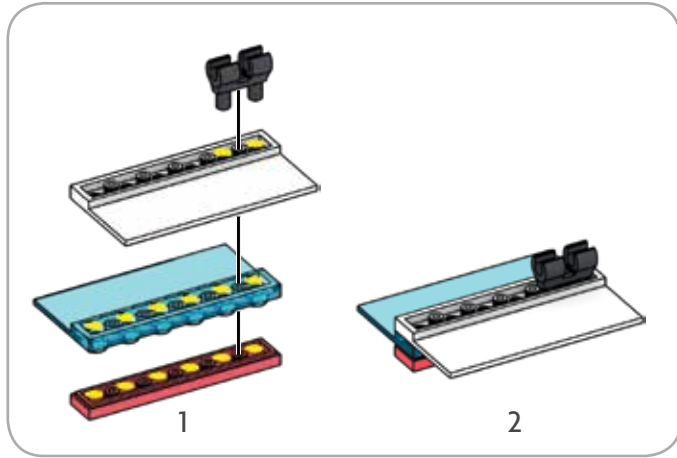



99



2x



2x



1x



1x

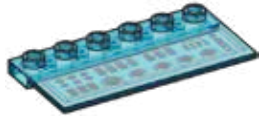

1x

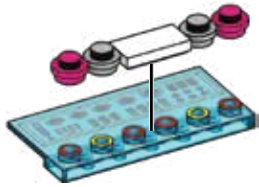

1



2



3



4



100

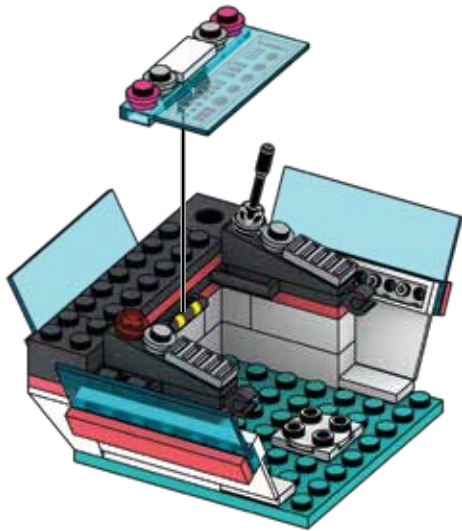

1



2

BUILDING TIP • CONSEIL UTILE CONSEJO PARA CONSTRUIR DICA DE MONTAGEM

Clip the command console gently into place.
Thumbs up, trainee!

Attache la console de commande doucement
en place. Bravo, stagiaire!

Coloca la consola de comando delicadamente en su lugar.
¡Pulgares arriba, aprendiz!

Conecte suavemente o console
de comando em seu lugar. Bravo!





101



5x



1x



1x



1x



1x



1x



1



2



1

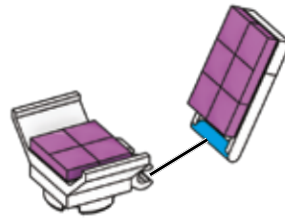

2



3

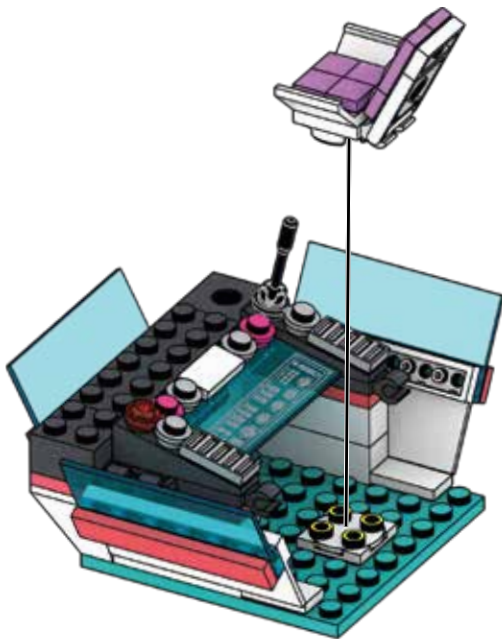

1

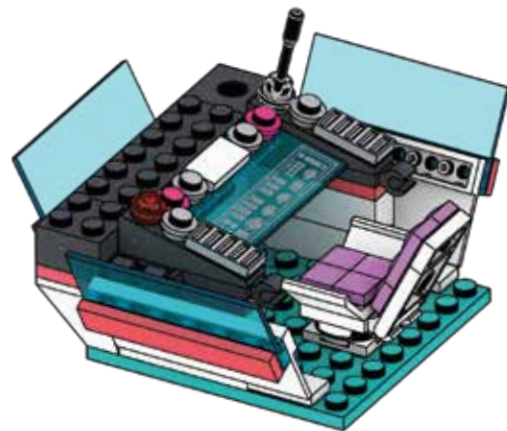

2

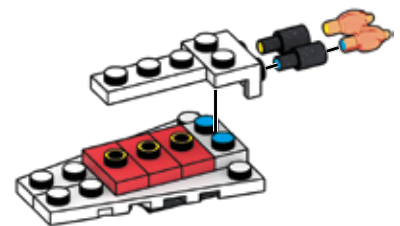
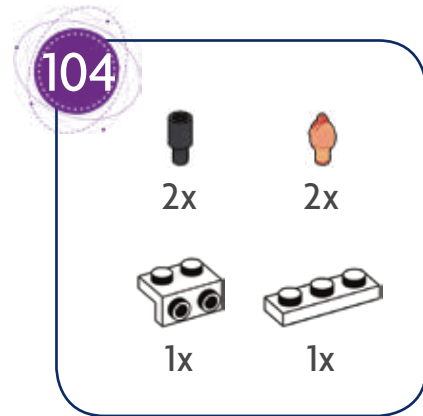
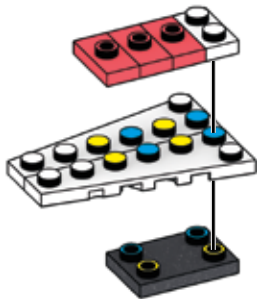
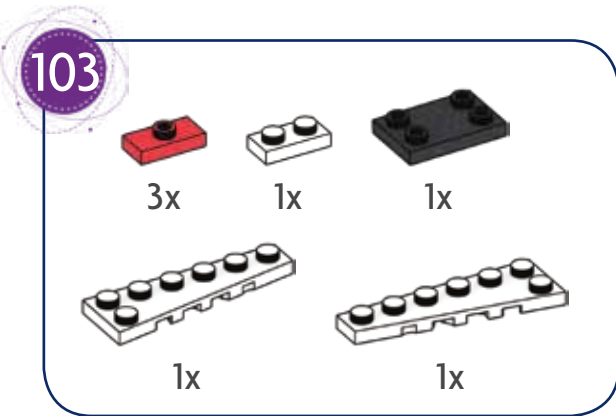
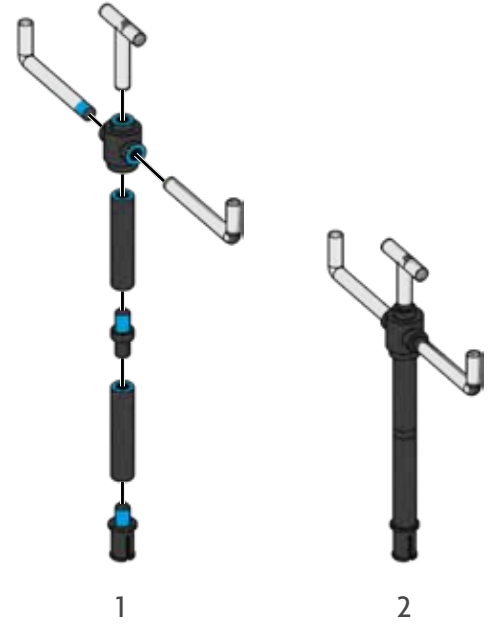



105



1x



3x



1x



1x

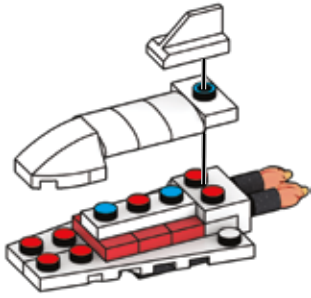

1

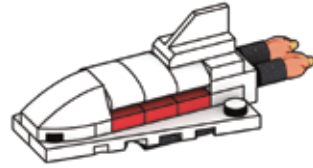

2

106



1x



1x



1x

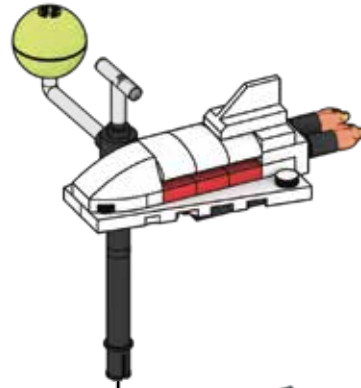
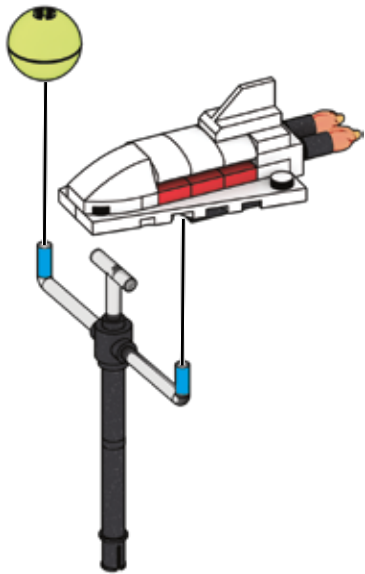
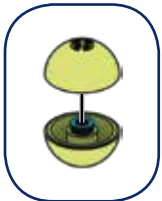



107



1x



1x



1x



1



2

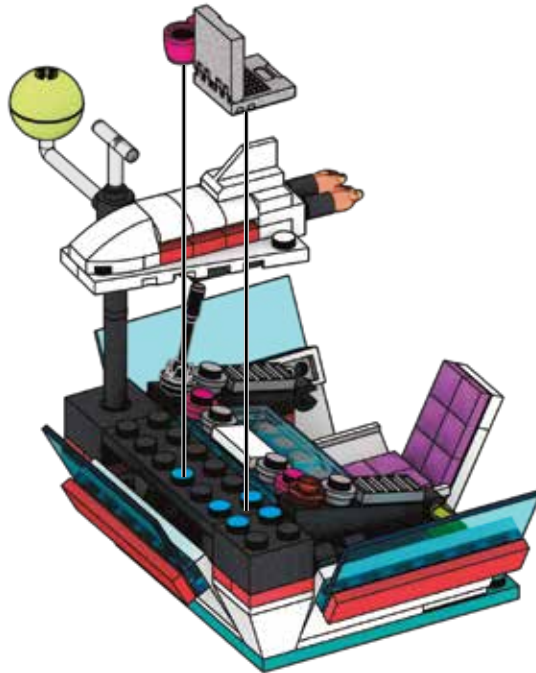



108

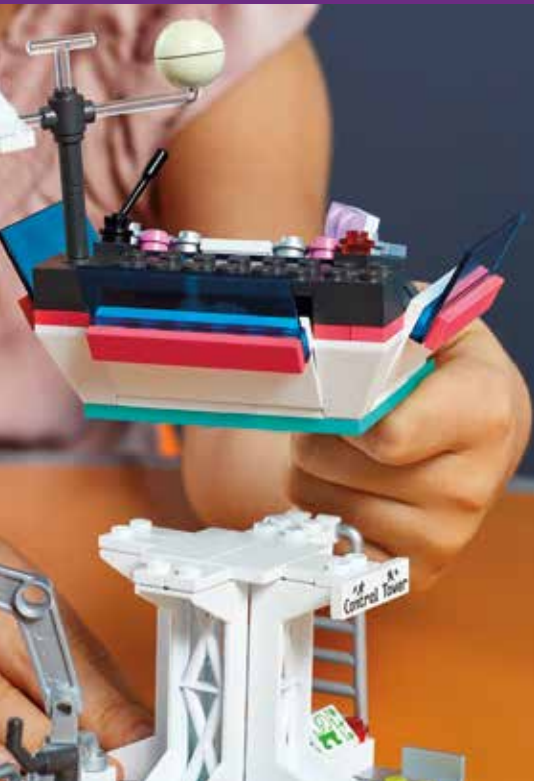
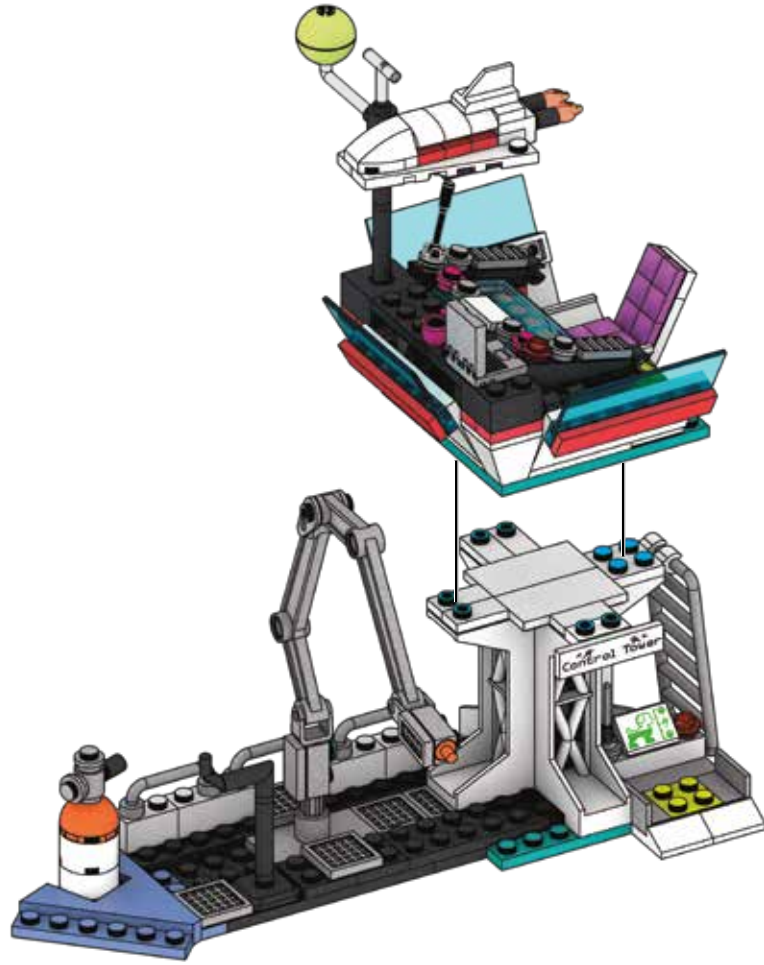

BUILDING TIP • CONSEIL UTILE CONSEJO PARA CONSTRUIR DICA DE MONTAGEM

Make sure mission control is centered before you attach the base. Well done! Now Luci can take a seat and head up operations.

Assure-toi que le centre de contrôle est centré avant de l'attacher à sa base. Bien joué ! Maintenant Luci peut prendre place et diriger les opérations.

Asegúrate de que el centro control esté centrado antes de unir la base. ¡Bien hecho! Ahora Luci puede tomar asiento y dirigir las operaciones.

Certifique-se que o controle de missão está bem centrado antes de conectar à base. Muito bem! Agora Luci pode se sentar e comandar as operações.



109



2x

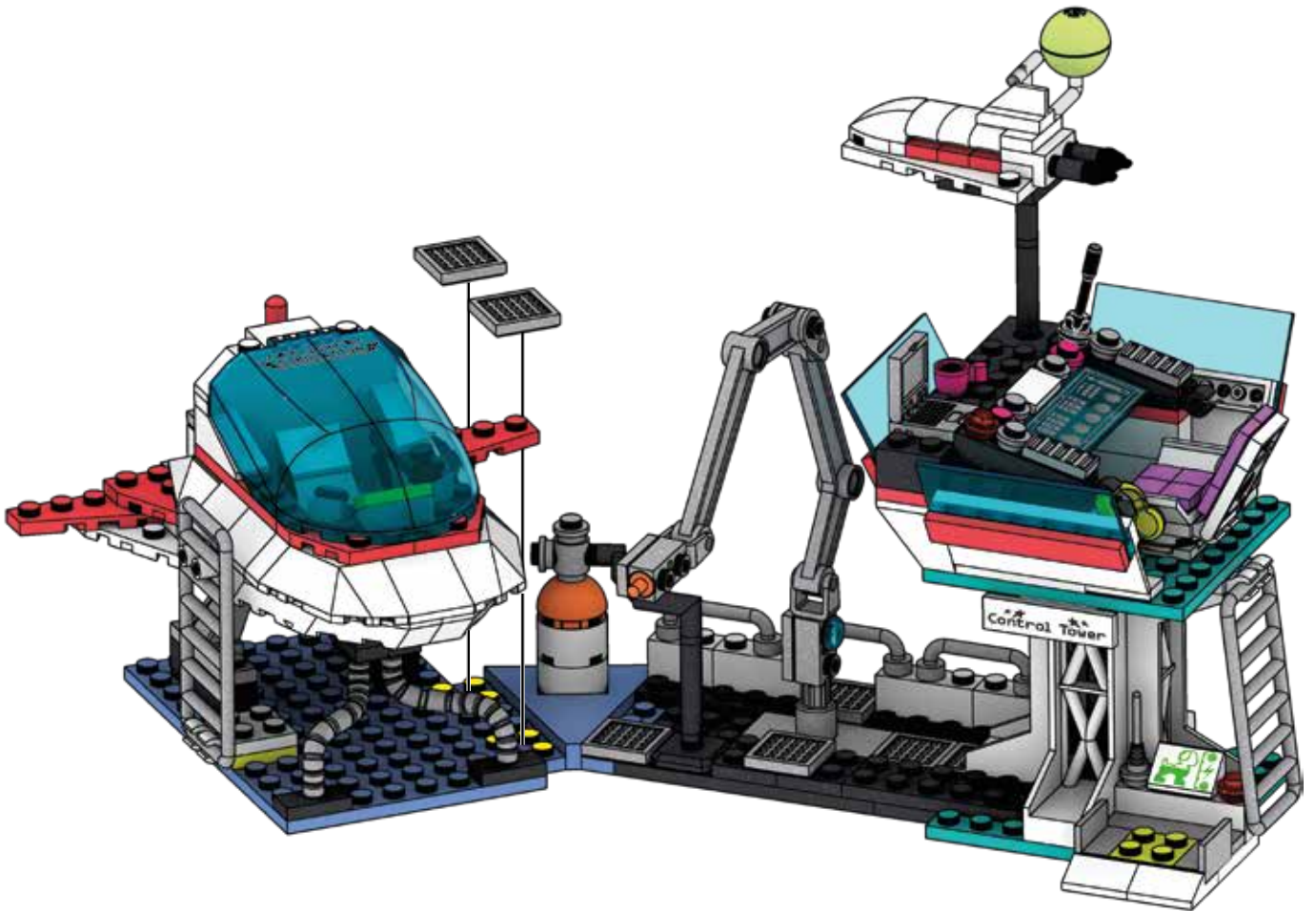



110

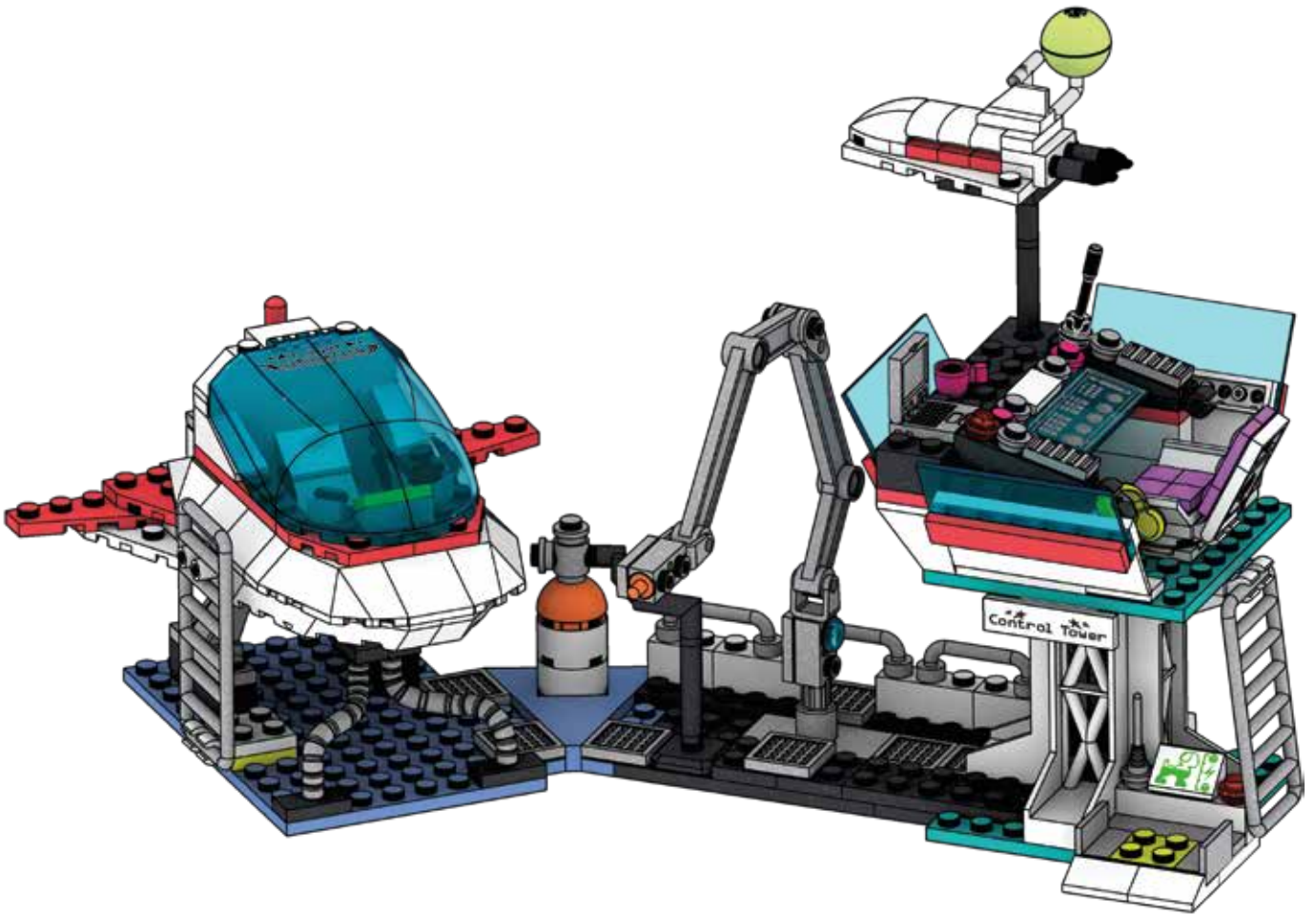



CONGRATULATIONS!

You've built Luciana's
Space Camp® Adventures.

BEAU TRAVAIL!

Tu as construit Luciana's
Space Camp® Adventures.

¡BIEN HECHO!

¡Construiste Luciana's
Space Camp® Adventures.

BOM TRABALHO!

Você montou Luciana's
Space Camp® Adventures.

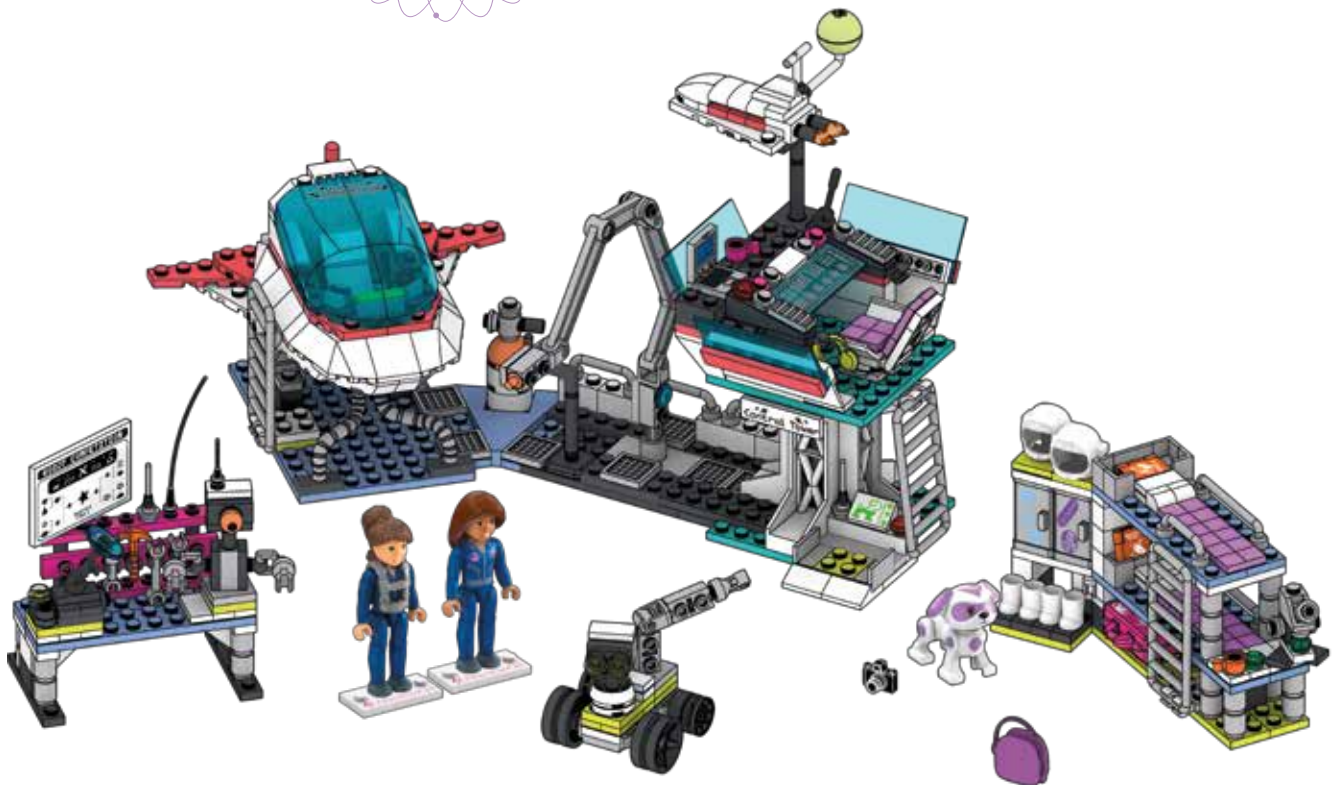

CREATE YOUR STORY • CRÉE TON HISTOIRE
CREA TU PROPIA HISTORIA • CRIE A SUA HISTÓRIA

You can create even more American Girl stories online.
Build your own stories and discover what other girls have created.
Because together, we Build Beyond™!



Tu peux créer encore plus d'histoires American Girl en ligne.
Construis tes propres histoires et découvre ce que d'autres filles
ont créé. Parce qu'ensemble, on peut construire au-delà!

Puedes crear más historias de American Girl en línea.
Crea tus propias historias y descubre lo que otras niñas han
creado. Porque juntas, ¡construimos en grande!



Você pode criar mais histórias em American Girl online!
Monte a suas histórias e descubra o que as outras meninas
já criaram. Porque juntas, Construimos Além™!



LUCIANA'S ACTIVITIES • LES ACTIVITÉS DE LUCIANA
ACTIVIDADES DE LUCIANA • ATIVIDADES DA LUCIANA

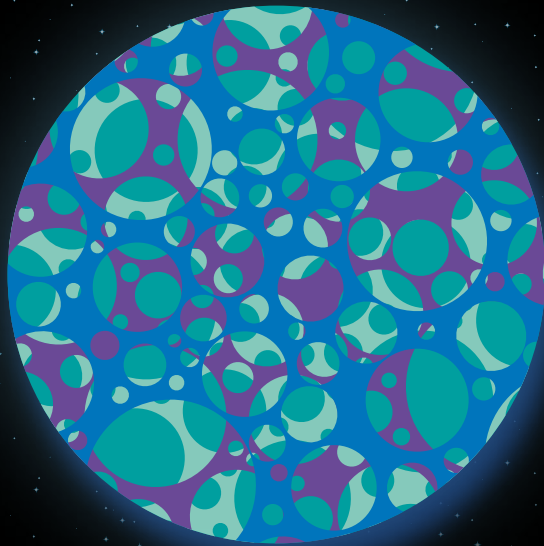

FIND THE MATCH
TROUVE LA PAIRE
ENCUENTRA EL PAR
ENCONTRE O PLANETA CORRESPONDENTE

A

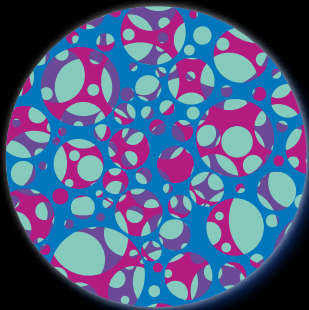

B

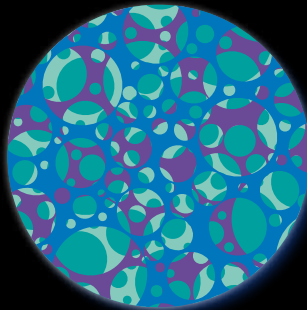

C

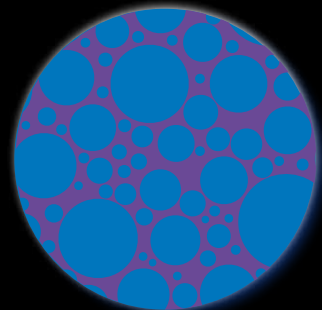

D

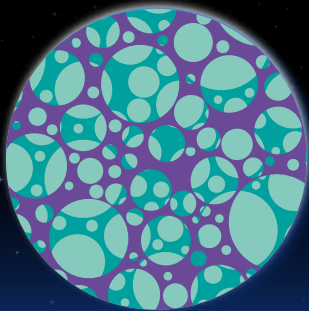

E

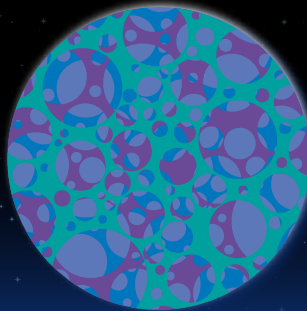

F

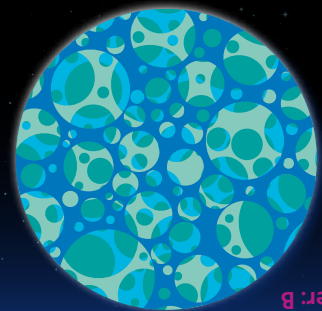

Answer: B



Connect the Dots
Relie les points
Conecta los puntos
Conecte os pontos

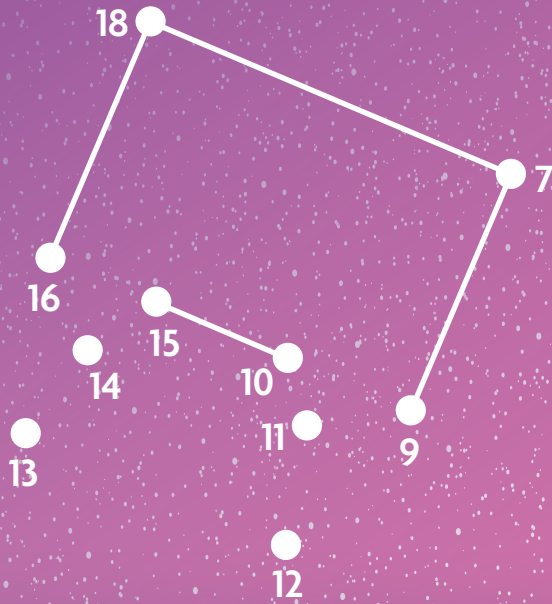
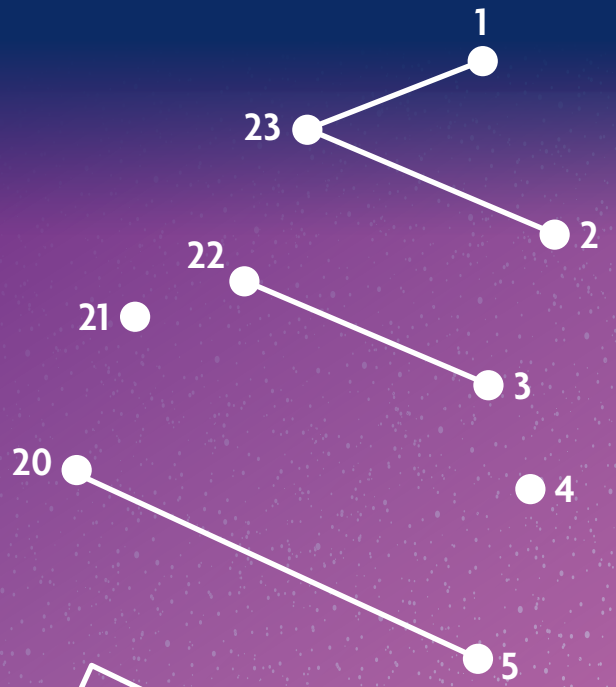

17

16

14

13

15

10

11

9

12

7

18

8

6

4

5

20

21

22

23

1

2

3



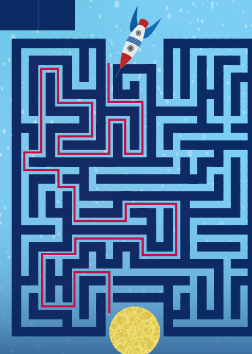
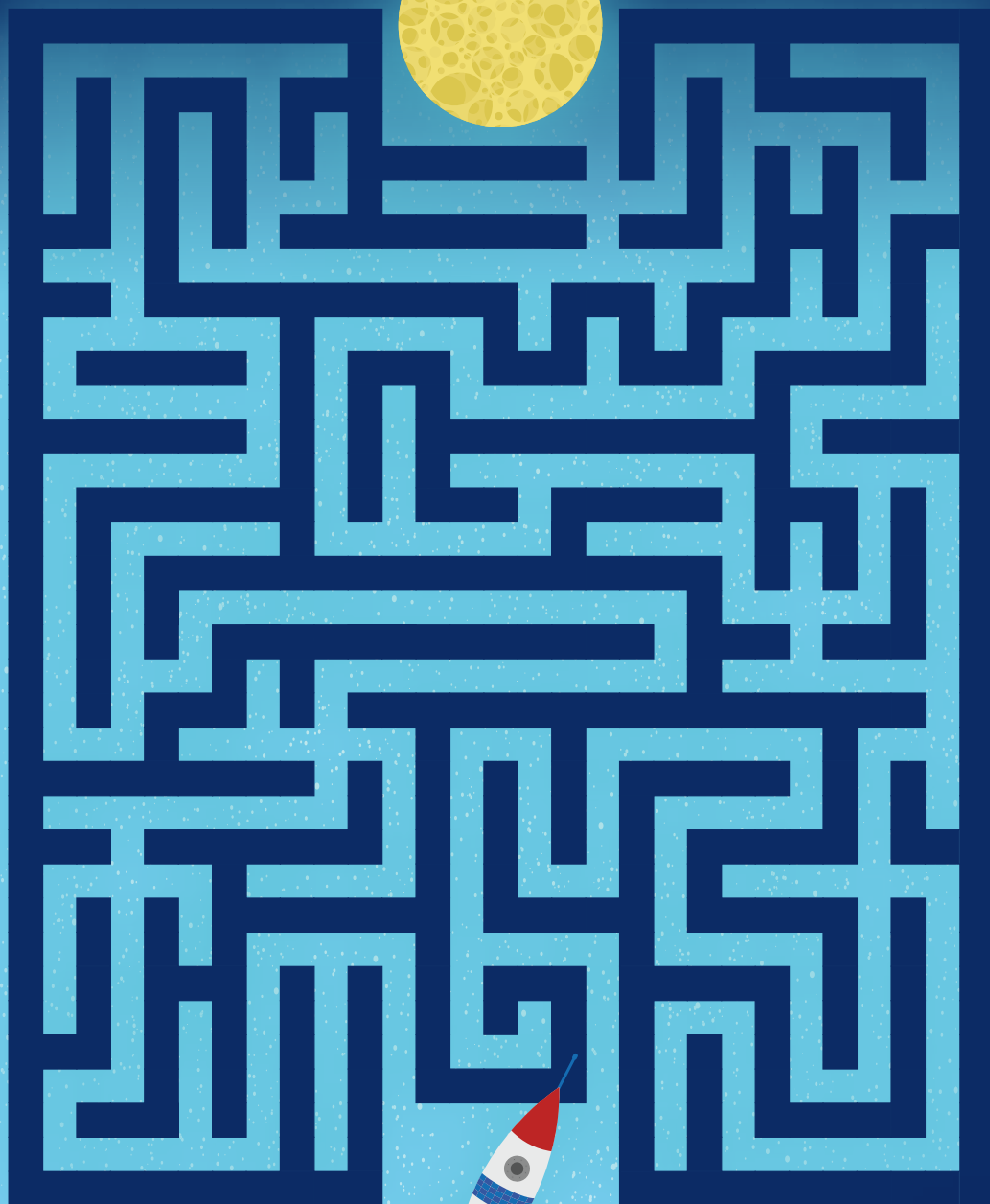
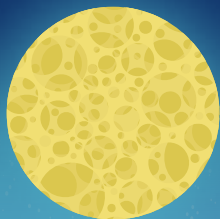

ANSWER • RESPONSE • SOLUCIÓN • SOLUTION

Moon Maze
Labyrinthe de la Lune
Laberinto lunar
Labirinto lunar

2x
AM77583RQ

2x
AM75332AAV

2x
AM04637AXK

1x
AM78802AAD

2x
MA1113GW

9x
MA1113APG

1x
MA18560MM

3x
M1113Z

5x
M1113X

4x
AM15026F

1x
MA1140MM

2x
AM76058E

4x
MA17787E

2x
AM72001APG

4x
MA15258E

1x
AM79638GW

1x
AM79638ABH

7x
MA17062MM

8x
MA17003MM

3x
AM72244AAD

1x
AM72244MM

1x
AM72534F

2x
AM76412KC

8x
MA74397MM

4x
MA72090MM

1x
AS-FTY39-01

3x
AM15555E

2x
MA16975MM

1x
AM18272APG

2x
MA1322E

1x
AM18660APG

6x
AM76959APG

22x
MA0910APG

1x
AM02172MM

1x
AM02172APG

1x
AM17507MM

1x
AM76892APG

1x
AM72922F

5x
AM77177APG

2x
MA76467E

1x
AM18014E

4x
MA07228APG

2x
MA19650APG

1x
AM77179APG

4x
AM73448APG

3x
AM77178APG

4x
MA73758ANY

10x
MA73758E

2x
MA07590ANY

3x
MA07590RQ

11x
MA07590MM

1x
MA07590E

4x
MA18756APG

2x
MA09198APG

2x
MA022501APG

13x
MA022501E

1x
AS-FTY39-12

3x
MA022501ANY

17x
MA76413ASY

4x
MA09393MM

5x
MA09393RQ

16x
MA09393E

4x
MA16680MM

2x
MA16649MM

4x
AM17070MM

1x
AM18269E

12x
MA09013E

5x
MA09013MM

1x
AM76560E

1x
AM76559E

4x
MA07658E

1x
MA17502E

1x
MA74428MM

5x
MA15484MM



4x
MA15484E



2x
MA17153E



2x
AM78189E



3x
AM73862MM

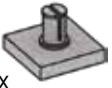

2x
AM01495APG



1x
AM73009MM



1x
MA03485E



1x
AS-FTY39-04



1x
AS-FTY39-05



1x
AS-FTY39-13



1x
AS-FTY39-14



1x
AS-FTY39 02



1x
AM15013APG



1x
MA09268E



4x
MA0948ANY



8x
AM18525APG



5x
MA03773ANY



1x
MA18329E



4x
MA18328E



1x
AM18300MM



1x
MA09023MM



1x
MA09023E



4x
MA1154E



7x
MA10273E



1x
AM74414AAV



1x
MA03484E



2x
MA74677E



1x
AM04245AAD



1x
AM77723ATY



1x
AM77724ATY



1x
AM17010E



2x
MA1320E



1x
AM77206APG



1x
AM76653APG



1x
AM72264APG



1x
AM76052MM



2x
MA74645MM



3x
MA72233MM



2x
MA18256MM



2x
AM77738W



1x
AM78715ABH



4x
AM15025F



1x
AM18628W



2x
AM01683APG



1x
AM72249F



2x
AM17392MM



2x
AM74057MM



1x
AS-FTY39-08



1x
AS-FTY39-09



1x
AM19529E



1x
AM74848MM



2x
MA03772ANY



1x
AM17605E



2x
AM19397APG



2x
AS-DPK83-06



8x
MA09493E



4x
MA09493MM



2x
AM18282RQ



2x
AM18283RQ



2x
MA1323E

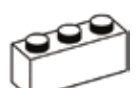

6x
MA16384E

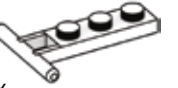

1x
AM17116E

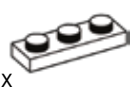

2x
MA1314E



1x
MA04497E



2x
AM77199MM



1x
AM74064RQ



1x
AM74065RQ



5x
MA09593E



2x
MA09838APG



1x
AS-FTY39-07

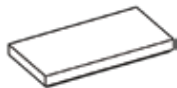

2x
AM77463E

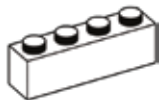

9x
MA1087E



3x
MA1087MM



1x
MA17503E



1x
AM78804AXJ



1x
AM77703ANY



1x
AS-FTY39-10



1x
AM78171GW



1x
AM76570AEN



1x
AM79019MCX



1x
AM79020BDG



1x
AM79592MCX



1x
AM18222F



8x
MA09292RQ



2x
MA09292MM



2x
MA09292E



3x
MA16331RQ

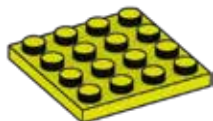

1x
MA17054ANY



3x
AM72333E



3x
AM72333AAV



1x
AS-FTY39-06



1x
AS-FTY39-03



1x
AM72010E



1x
AM72011E

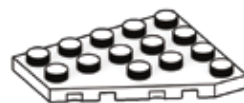

1x
MA18281E



1x
MA18280E



4x
MA1480MM



3x
AM77205GW

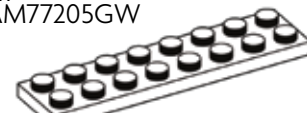

2x
MA08483E

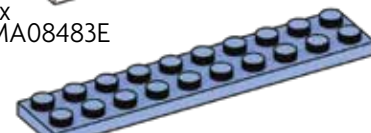

5x
MA09923QW

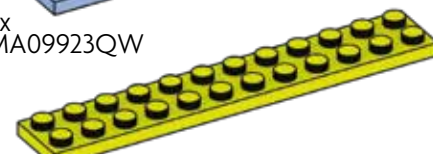

2x
MA1172ANY

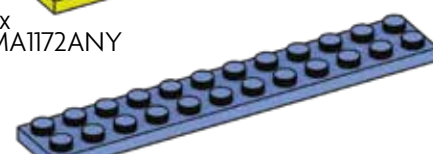

2x
MA1172QW



1x
MA74678MM

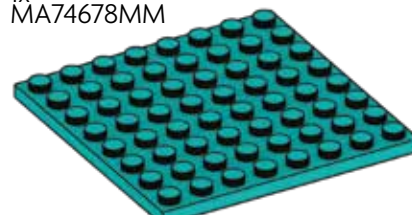

2x
MA18556CV

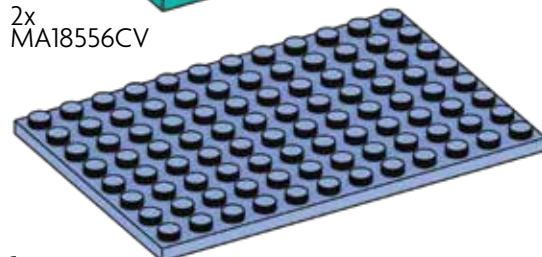

1x
AM73755QW

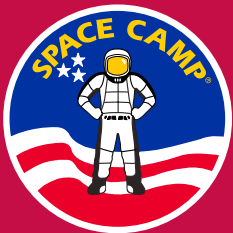
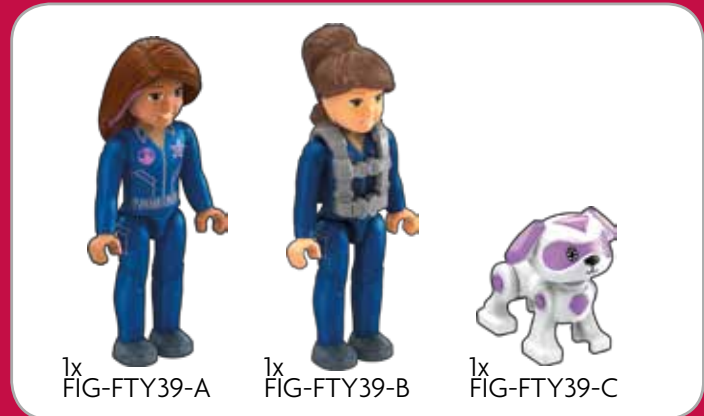
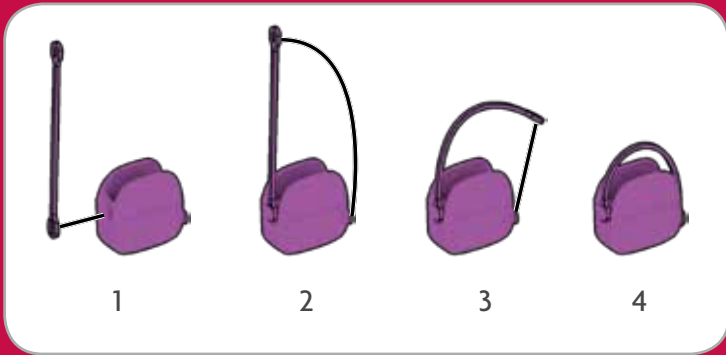
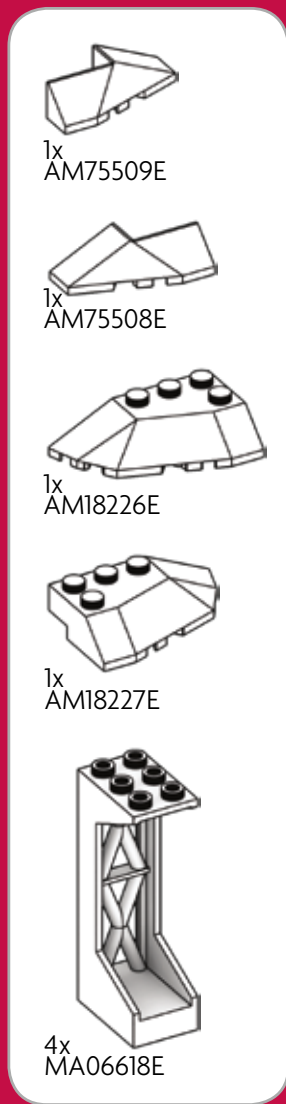

Please read these instructions carefully before first use and keep them for future reference. Il est recommandé de lire attentivement ce feuillet avant la première utilisation et de le conserver pour référence future. Leer estas instrucciones cuidadosamente antes de la primera utilización y guardarlas para referencia futura. Leia as instruções antes do primeiro uso e guarde-as para futura referência.

© 2018 American Girl. All rights reserved. Todos los derechos reservados. Tous droits réservés. All American Girl marks are trademarks of American Girl. Marcas registradas utilizadas bajo licencia. American Girl ainsi que les marques et designs y afférents appartiennent à American Girl.

Space Camp® is a registered trademark and service mark of the U.S. Space & Rocket Center®. All rights reserved. ©2018 Alabama Space Science Exhibit Commission.

⚠️ **WARNING:**
CHOKING HAZARD. - Small parts.
Toy contains a small ball.
Not for children under 3 years.

⚠️ **ATTENTION:**
DANGER D'ÉTOUFFEMENT. - Présence de petits éléments.
Le jouet contient une petite balle.
Ne convient pas aux enfants de moins de 3 ans.

ADVERTENCIA: Peligro de atragantamiento. Juguete no recomendado para menores de 3 años, porque contiene piezas pequeñas / bolitas que podrían provocar asfixia en caso de ser ingeridas o inhaladas por el/la niño/a.

ATENÇÃO: Não recomendável para crianças com menos de 36 meses. Contém peças pequenas / bolas pequenas. Capazes de criar risco de asfixia.



P D714,887

P D781,964

P D797,203



American Girl®

More to collect! • Bien plus à collectionner!! • ¡Más juguetes para coleccionar! • Mais para coleccionar!

Luciana Vega™



FML67

Julie ALBRIGHT™



FML68

Maryellen LARKIN™



FTY37



Samantha PARKINGTON™



FTY40

Each sold separately and subject to availability. Produits vendus séparément, selon la disponibilité. Se venden por separado y están sujetos a disponibilidad. Vendidos em separado e sujeitos à disponibilidade.

©2018, MEGA Brands Inc. &™ MEGA Brands Inc. CONSTRUX™ is owned by Mattel and used under license. CONSTRUX™ appartient à Mattel et est utilisée sous licence. Printed in Canada D-FTY39-01



play.megaconstrux.com